

TURBOFAN ENGINE

Robert Jakubowski PhD

Rzeszow University of Technology

Aerospace Engineering Department

robert.jakubowski@prz.edu.pl

LITERATURE:

- **Jack D. Mattingly, Elements of Propulsion: Gas Turbines and Rockets, AIAA Education Series 2006 (Chapter 7)**
- **Jack D. Mattingly, Elements of Gas Turbine Propulsion, Tata McGraw Hill Education Private Limited, 2013 (Chapter 7)**
- **Gordon C. Oates, Aerothermodynamics of Gas Turbine and Rocket Propulsion, AIAA Education Series, 1997 (Chapter 7)**

CLASSICAL TURBOFAN ENGINE

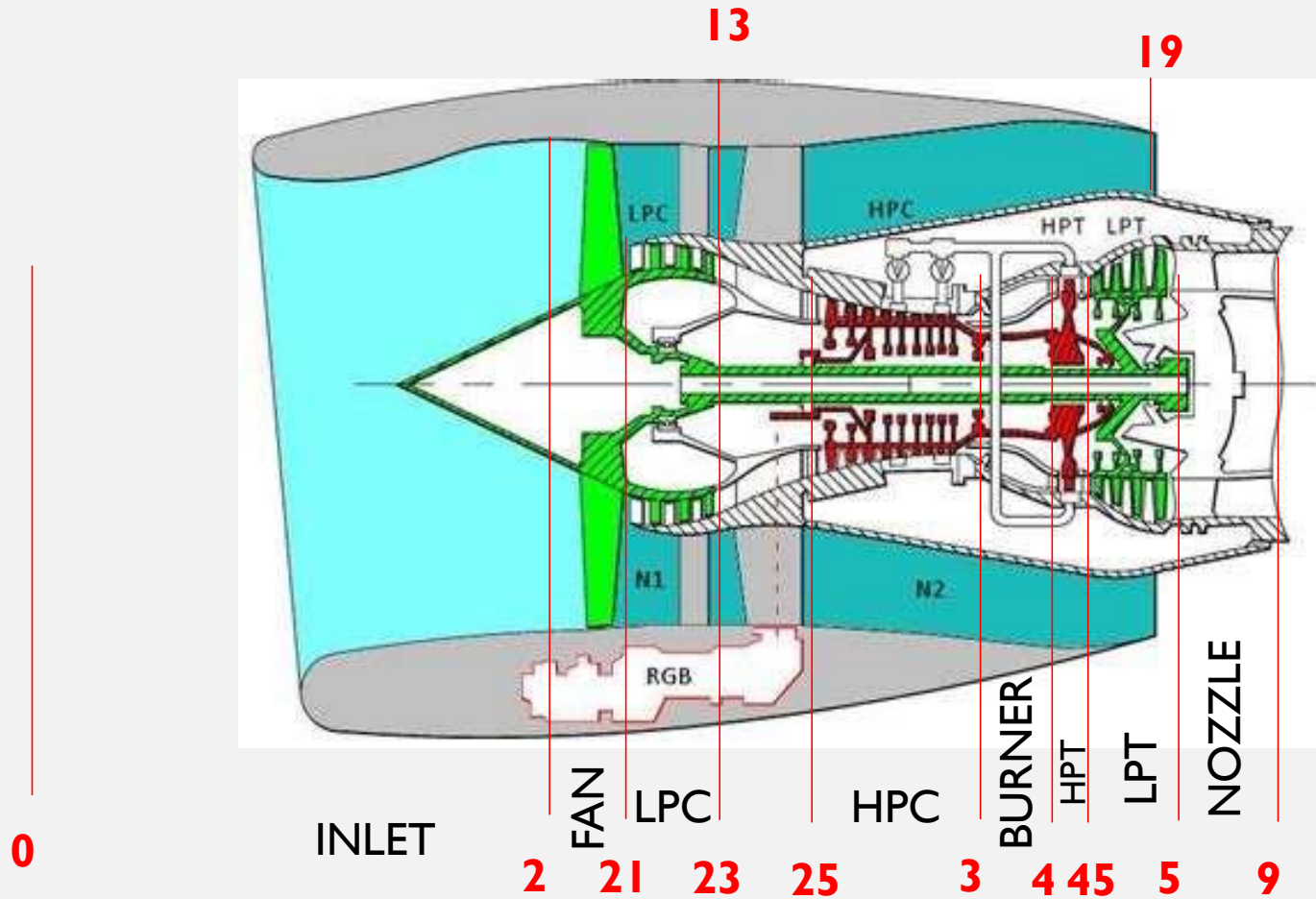

TURBOFAN ENGINES REVIEW

MIDDLE BPR TURBOFAN ENGINE

JT15D-5D

$T_{\text{take off}} = 13,54 \text{ kN}$

$\text{SFC} = 0.55 \text{ daN/h}$

$\text{BPR} = 3,3$

$\text{Mass} = 292,6 \text{ kg}$

$\text{Length/Diameter} = 1531/520 \text{ mm}$

$N1 = 15,900 \text{ RPM}$, $N2 = 32,760 \text{ RPM}$

Application: Cessna CitationV, Hawker 400

Two shaft engine.

It consists of: single stage fan, single stage LPC, centrifugal HPC, reverse flow combustor, single stage HPT, two stages LPT, separated nozzles of core engine and external duct

JT15D Turbofan

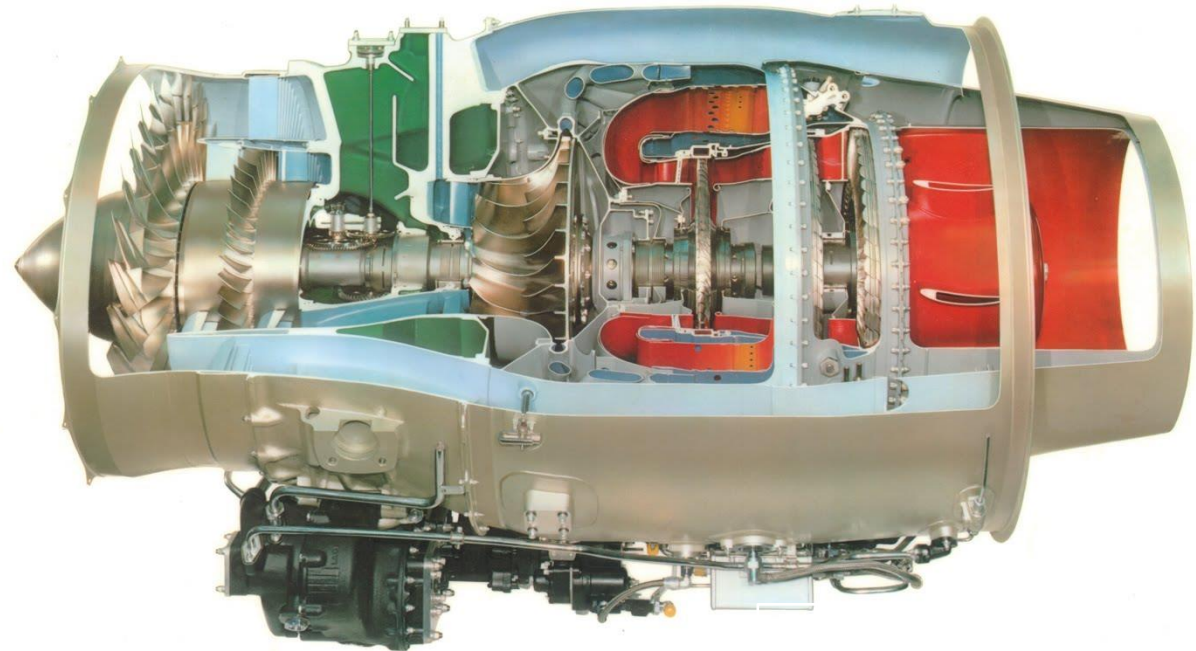

HIGH BYPASS-RATIO TURBOFAN

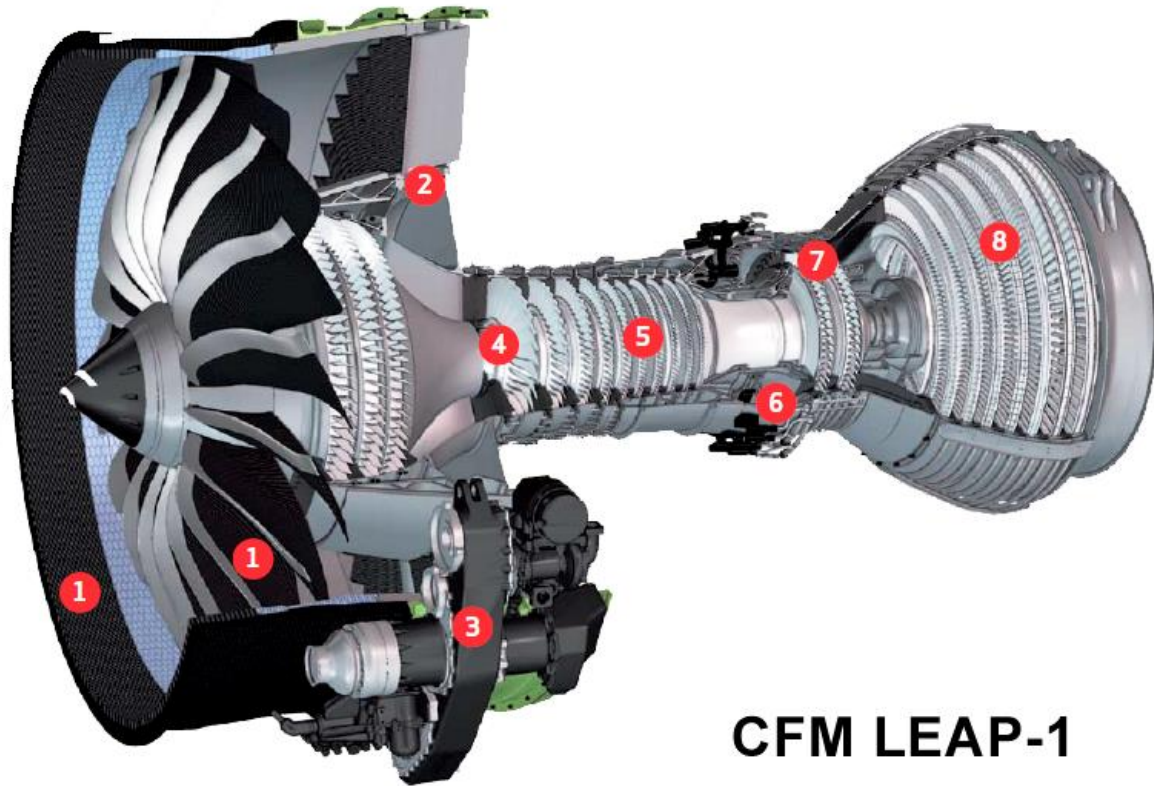

CFM LEAP-1

LEAP A I

Compressors: OPR=40:

F – Single stage, LPC – 3 stages, HPC - 10 stages

Combustor – second generation Twin-Annular

Turbines HPT – 2 stages, LPT – 7 stages

BPR 11

Length 3,328 m/ Diameter 1,93 m

MTO 143 kN

MCT 141 kN

N1=3894 RPM, N2=19391 RPM

Application A-320

GEARED TURBOFAN (GTF)

PW1100G

F – 1 stage LPC 3 stage, HPC 8 stage

Turbines: HPT – 2 stages, LPT – 3 stages

Gear 3,3:1

BPR – 12,5

Lenth/Diameter 3,4 m / 2,224 m

Weight 2857 kg

MTO 147 kN (33G) 120 kN (27G) 108 kN (24G)

Rotor speed: Fan – 3281 RPM, LP – 10047 RPM, HP 22300 RPM

Application: A320 Neo

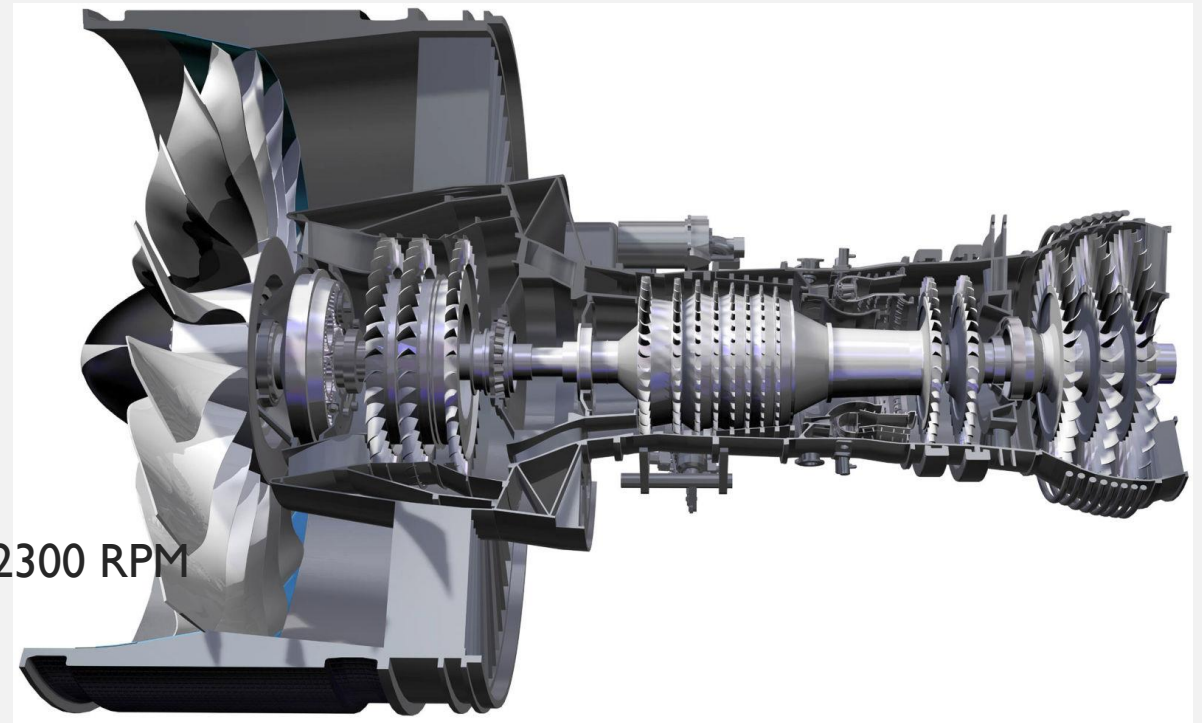

GTF VS CLASSICAL TURBOFAN

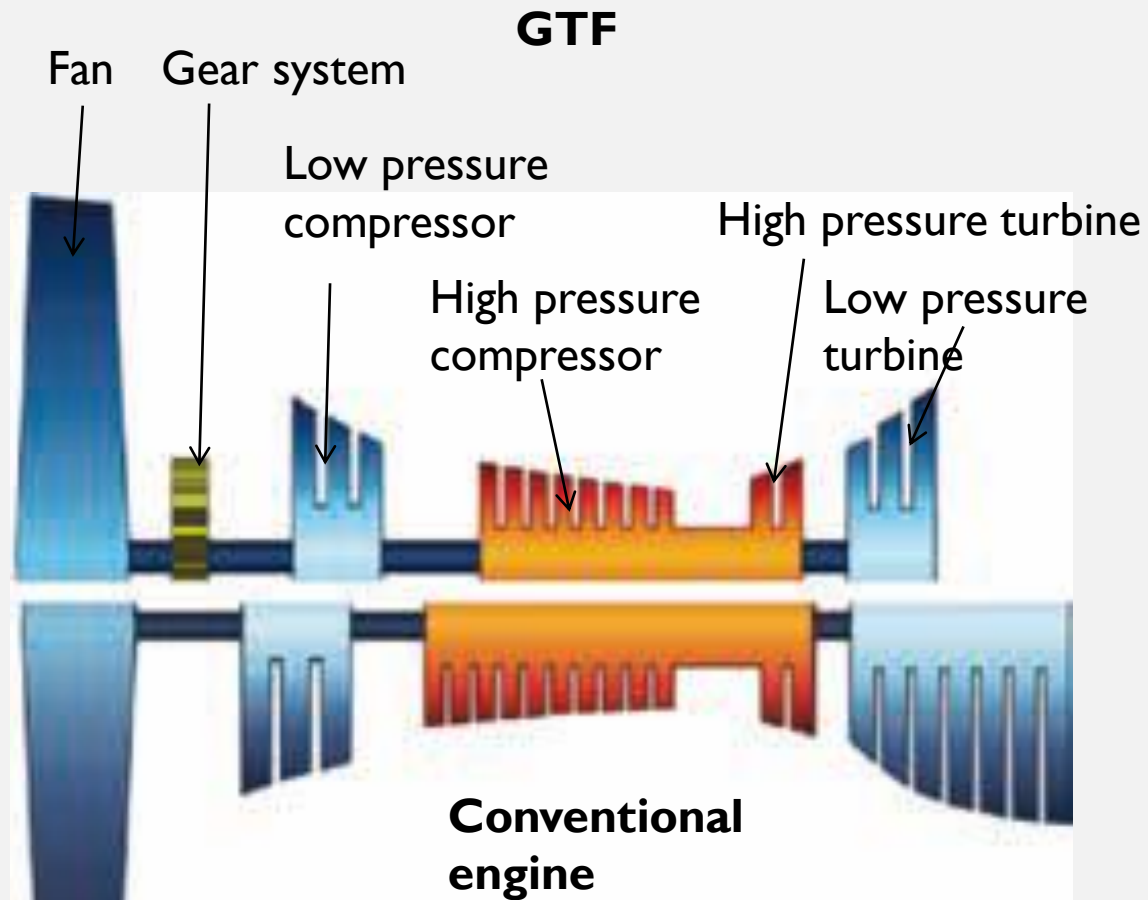

GTF got:

- Higher work of single LPT stage
 - Less LPT stages
- Higher LPC pressure of single stage
 - Less HPT stages

THREE SPOOL TURBOFAN ENGINE

Rolls-Royce Trent 7000

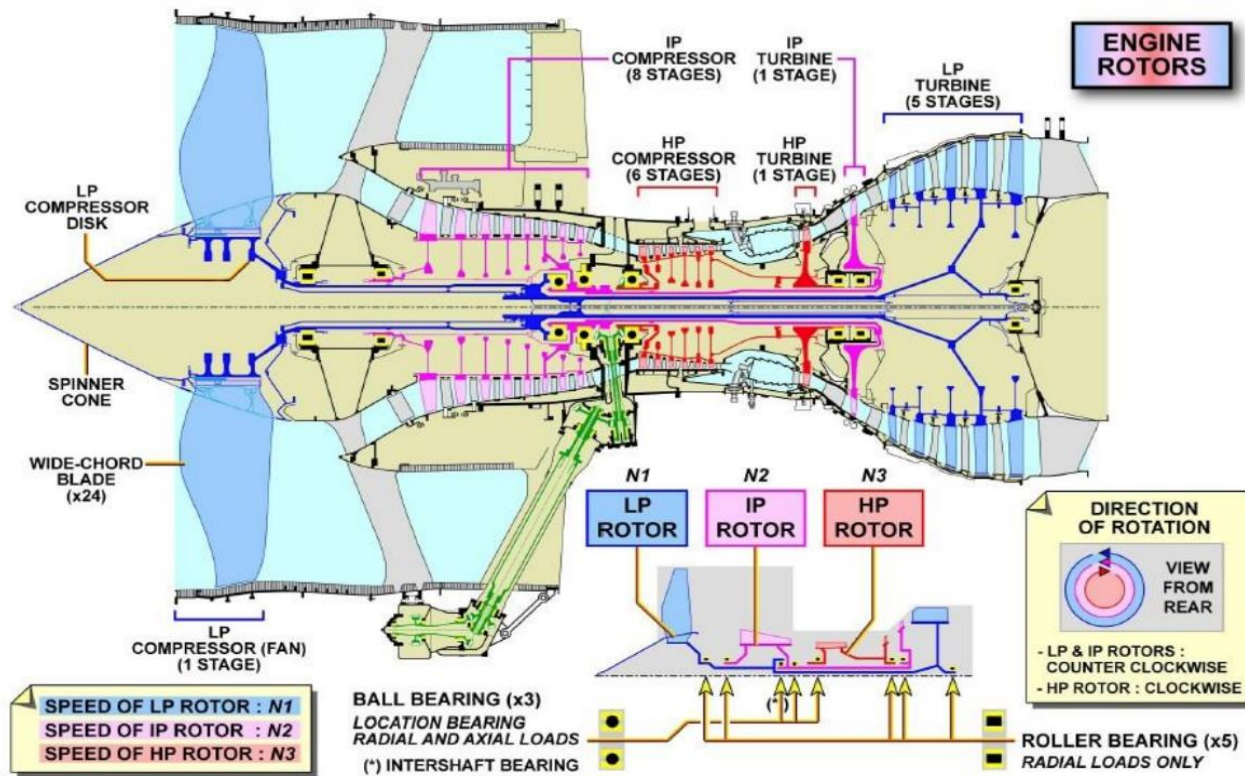

- **MTO:** 324,0 kN / 72 834 lbf
- **MCT:** 289,2 kN / 65 005 lbf
- **Pressure ratio :** 50:1
- **BPR :** 10:1
- **TIT:** > 1835 K (1562 °C; 2843 °F)
- **SFC (curse) =** 14,4 g/kN/s
- **Stosunek ciągu do masy :** 5,13
- **Rotation: (100%):**
- HP 13 391 RPM, IP 8937 RPM, LP 2683 RPM

Application: **A330 neo**

Coppressors:
 F – single stage
 IP – 8 stages
 HP – 6 stages

Turbines:
 LP – 6 stages
 IP – single stage
 HP – single stage

TURBOFAN ENGINE THRUST

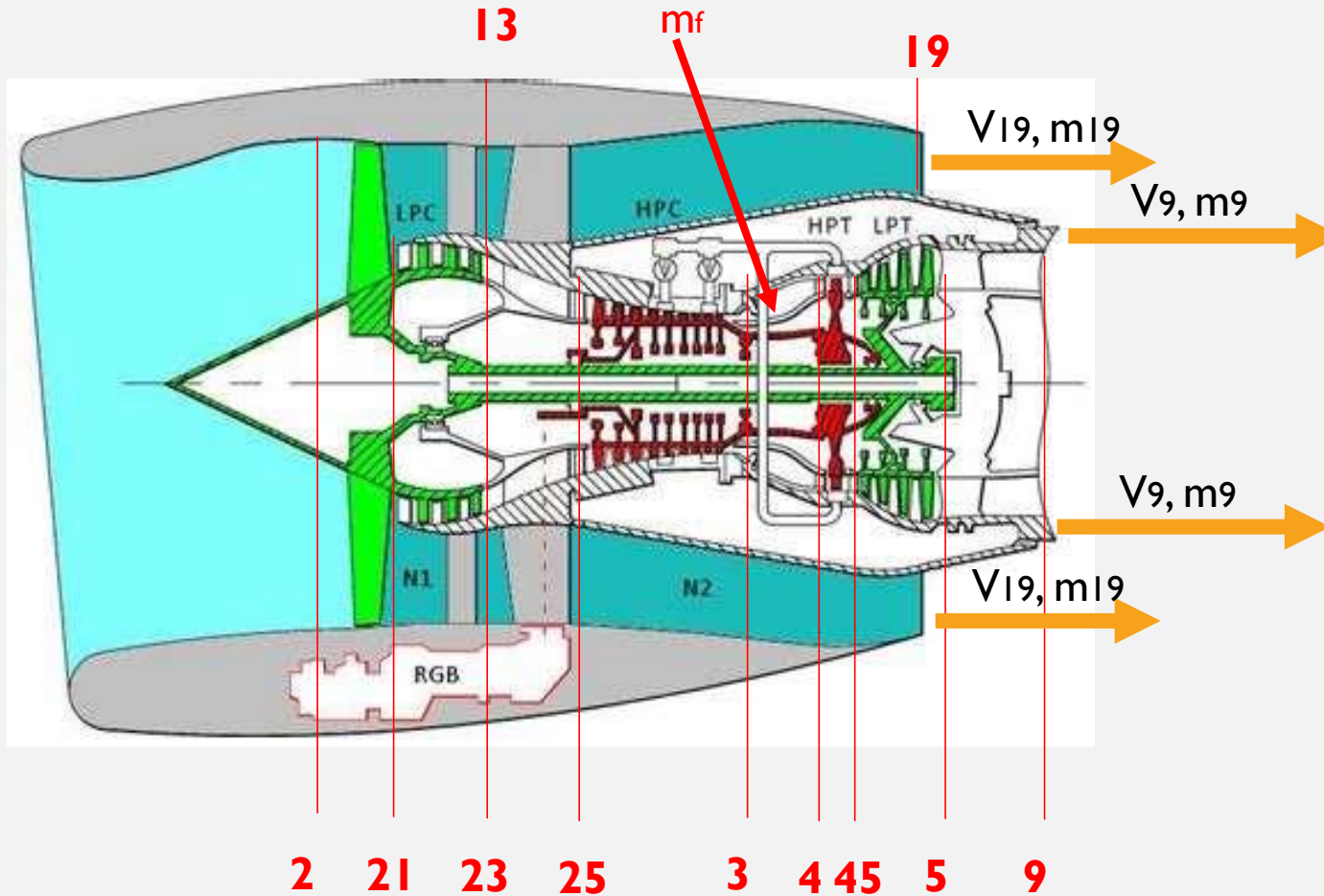

THRUST

$$T = \dot{m}_9 V_9 + A_9 (P_9 - P_0) + \dot{m}_{19} V_{19} + A_{19} (P_{19} - P_0) - \dot{m}_0 V_0$$

effective exhaust velocity

$$V_{e9} = V_9 + A_9 (P_9 - P_0) / \dot{m}_9$$

$$V_{e19} = V_{19} + A_{19} (P_{19} - P_0) / \dot{m}_{19}$$

$$T = \dot{m}_9 V_{e9} + \dot{m}_{19} V_{e19} - \dot{m}_0 V_0$$

Core engine exit mass flow

$$\dot{m}_9 = \dot{m}_{21} + \dot{m}_f$$

External exit mass flow

$$\dot{m}_{19} = \dot{m}_{13}$$

Bypass Ratio $BPR = \frac{\dot{m}_{13}}{\dot{m}_{21}}$

SPECIFIC THRUST AND SPECIFIC FUEL CONSUMPTION

SPECIFIC THRUST

$$ST = T/\dot{m}_0 = \frac{\dot{m}_9 V_{e9} + \dot{m}_{19} V_{e19} - \dot{m}_0 V_0}{\dot{m}_{21} + \dot{m}_{13}} = \frac{(1 + f_B)V_{e9} + BPR * V_{e19} - (1 + BPR)V_0}{1 + BPR}$$

Fuel/air ratio $f_B = \frac{\dot{m}_f}{\dot{m}_{21}}$

ST of turbofan engine goes down for higher BPR

SPECIFIC FUEL CONSUMPTION

$$\begin{aligned} SFC = \dot{m}_f/T &= \frac{\dot{m}_f}{\dot{m}_9 V_{e9} + \dot{m}_{19} V_{e19} - \dot{m}_0 V_0} = \frac{f_B}{(1 + f_B)V_{e9} + BPR * V_{e19} - (1 + BPR)V_0} = \\ &= \frac{\frac{f_B}{1 + BPR}}{\frac{(1 + f_B)V_{e9} + BPR * V_{e19} - (1 + BPR)V_0}{1 + BPR}} = \frac{f_B}{(1 + BPR) * ST} \end{aligned}$$

SFC goes down for higher BPR

TURBOFAN ENGINE EFFICIENCIES

Due to the fact, that the high BPR turbofan engine produces a lot of thrust by cold stream (external duct), therefore a significant amount of exit gas temperature is close to the ambient temperature. This generates low heat losses and high thermal efficiency.

Thermal efficiency

$$\eta_{TH} = \frac{\text{Power imparted to engine airflow}}{\text{Rate of energy supplied in the fuel}}$$

$$\eta_{TH} = \frac{0,5 * (\dot{m}_9 V_{9e}^2 + \dot{m}_9 V_{9e}^2 - \dot{m}_0 V_0^2)}{\dot{m}_f FHV} = \frac{0,5 * ((1 + f_B) V_{9e}^2 + BPR * V_{9e}^2 - (1 + BPR) V_0^2)}{f_B FHV}$$

Huge amount of exit flow of the high BPR turbofan engine passes through the external duct of low temperature therefore exit gas speed is low and only slightly higher than flight speed. By this way propulsive efficiency is high.

Propulsive efficiency

$$\eta_P = \frac{\text{Thrust power}}{\text{Power imparted to engine airflow}}$$

$$\eta_P = \frac{V_0 * T}{0,5 * (\dot{m}_9 V_{9e}^2 - \dot{m}_0 V_0^2)} = \frac{\dot{m}_0 V_0 * \frac{T}{\dot{m}_0}}{0,5 * (\dot{m}_9 V_{9e}^2 - \dot{m}_0 V_0^2)} = \frac{(1 + BPR) * V_0 * ST}{0,5 * ((1 + f_B) V_{9e}^2 + BPR * V_{9e}^2 - (1 + BPR) V_0^2)}$$

Overall efficiency

$$\eta_O = \eta_{TH} * \eta_P = \frac{V_0 * T}{\dot{m}_f FHV} = \frac{(1 + BPR) * V_0 * ST}{\dot{m}_f FHV}$$

TURBOFAN TEMPERATURE & PRESSURE DISTRIBUTION

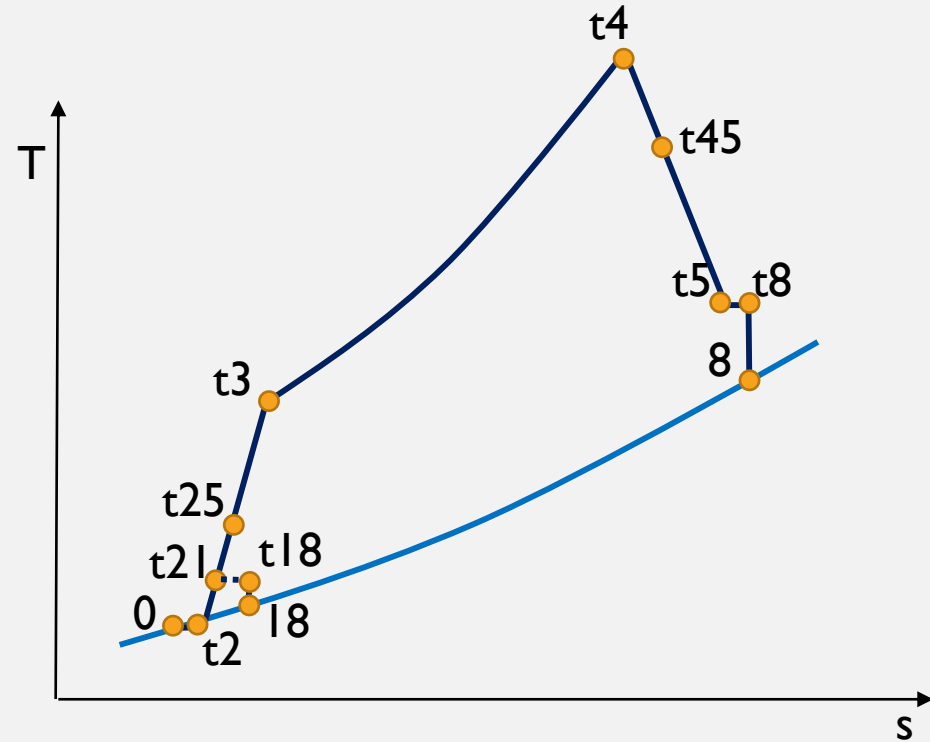
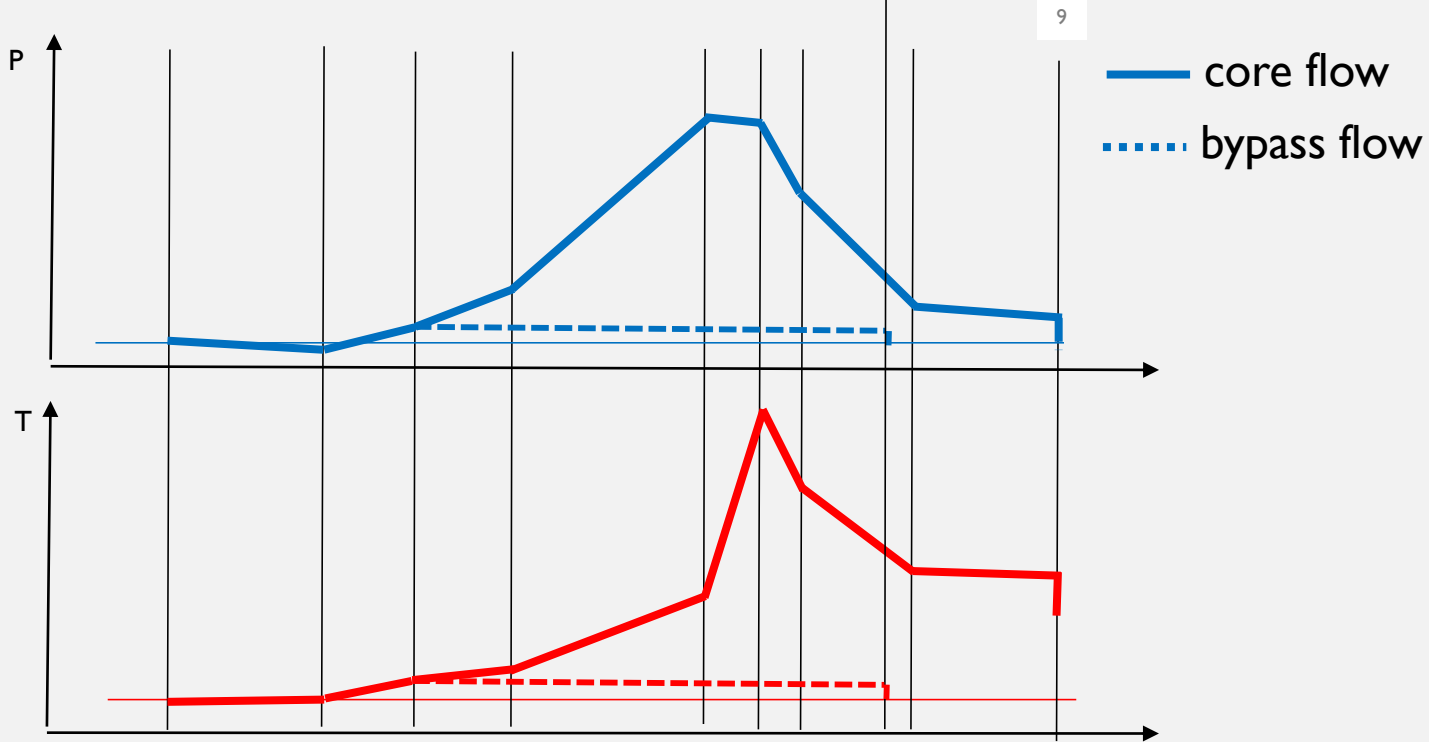
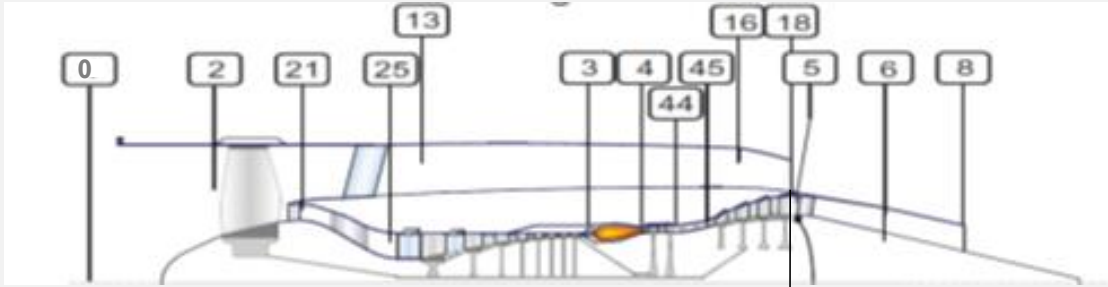

TURBOFAN ENGINE CALCULATION

Required data

- Ambient and flight conditions: H , M_0
- Engine cycle parameters: FPR, LPCPR, HPCPR, BPR, TIT
- Pressure losses: inlet, burner, external and internal nozzles, ducts
- Efficiencies: fan, LPC, HPC, LPT, HPT, burner, mechanical of spool1 and spool2

Assumptions:

- Fan and LPC and HPC are calculated according compressor standard
- External nozzle calculation is provided according nozzle calculation standard, but gas parameters specification is for air
- Mass flow related parameters are calculated on the mass flow in the core engine inlet m_{21} , therefore $f_B = m_f / m_{21}$.
- Nozzles are typically convergent, but often model is simplified by full expansion assumption

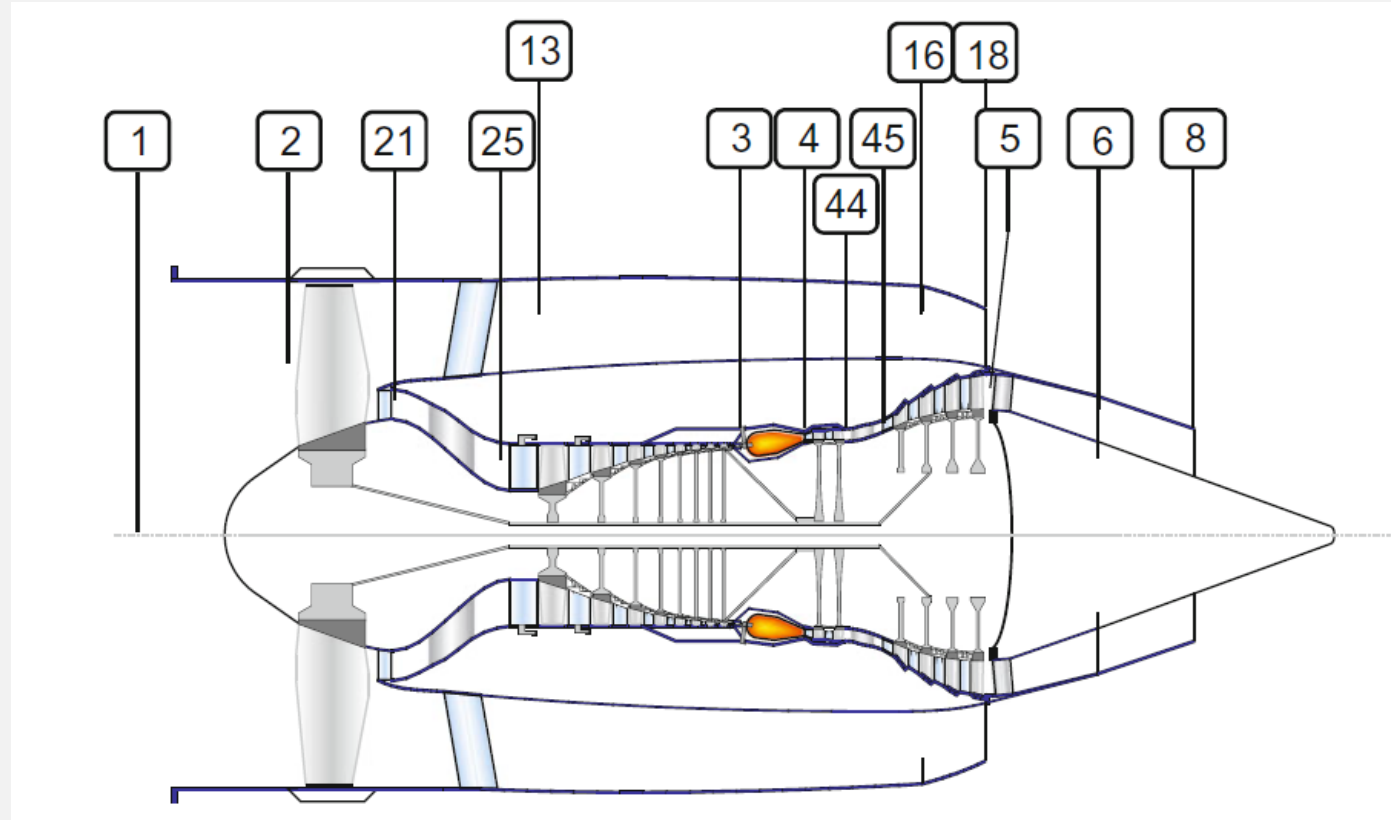

TURBOFAN ENGINE – SHAFTS POWER BALANCE

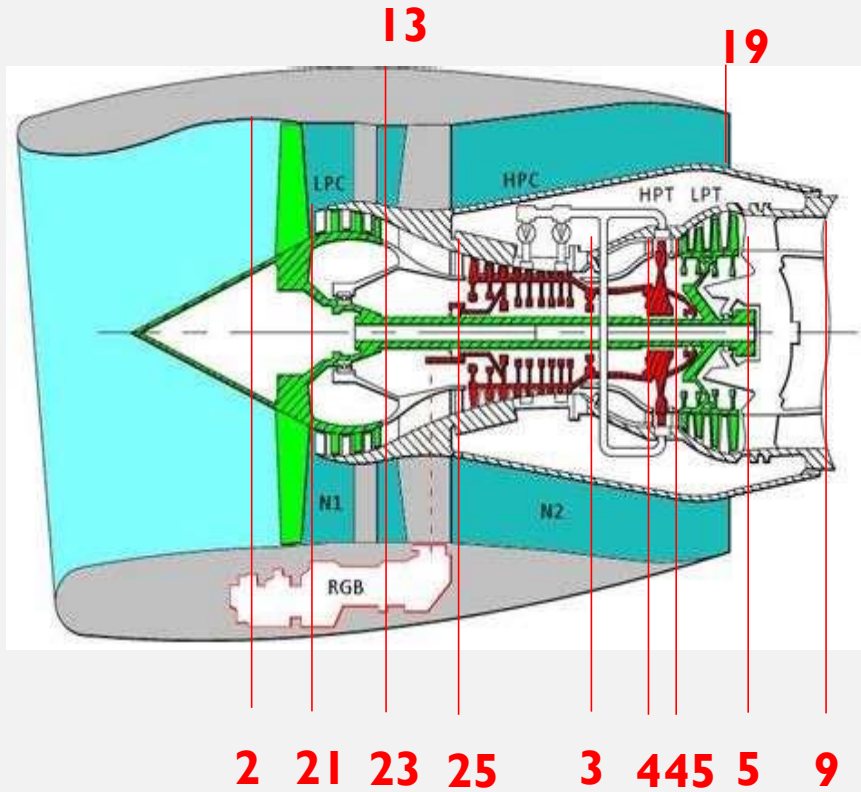

LP spool

$$P_F + P_{LPC} = T_{LPT}$$

$$\dot{m}_2 * cp(T_{t21} - T_{t2}) + \dot{m}_{21} * cp(T_{t23} - T_{t25}) = \dot{m}_{45} * cp_t(T_{t45} - T_{t5})$$

$$\dot{m}_{45} = \dot{m}_{21} + \dot{m}_f$$

$$(1 + BPR) * cp(T_{t21} - T_{t2}) + cp(T_{t25} - T_{t23}) = (1 + f_B) * cp_t(T_{t45} - T_{t5})$$

HP spool

$$\dot{m}_{21} * cp(T_{t3} - T_{t25}) = \dot{m}_4 * cp_t(T_{t4} - T_{t45})$$

$$\dot{m}_{45} = \dot{m}_{21} + \dot{m}_f$$

$$cp(T_{t3} - T_{t25}) = (1 + f_B) * cp_t(T_{t4} - T_{t45})$$

EXAMPLE OF TURBOFAN ENGINE CYCLE CALCULATION

GIVEN:

- Flight conditions: $T_0=217$ K, $P_0=22$ kPa, $M_0=0.88$, $BPR=9$, $FPR=1.6$, $CPR=20$, $TIT(T_{t4})=1600$ K, mass flow $m=100$ kg/s.
- $\pi_{IN} = 0.98$, $\pi_B = 0.98$, $\pi_{IN} = 0.97$, $\pi_{EN} = 0.96$, $\eta_F = 0.91$, $\eta_C = 0.83$, $\eta_{HPT} = 0.88$, $\eta_{LPT} = 0.9$, $\eta_{mHP} = 0.99$, $\eta_{mLP} = 0.995$

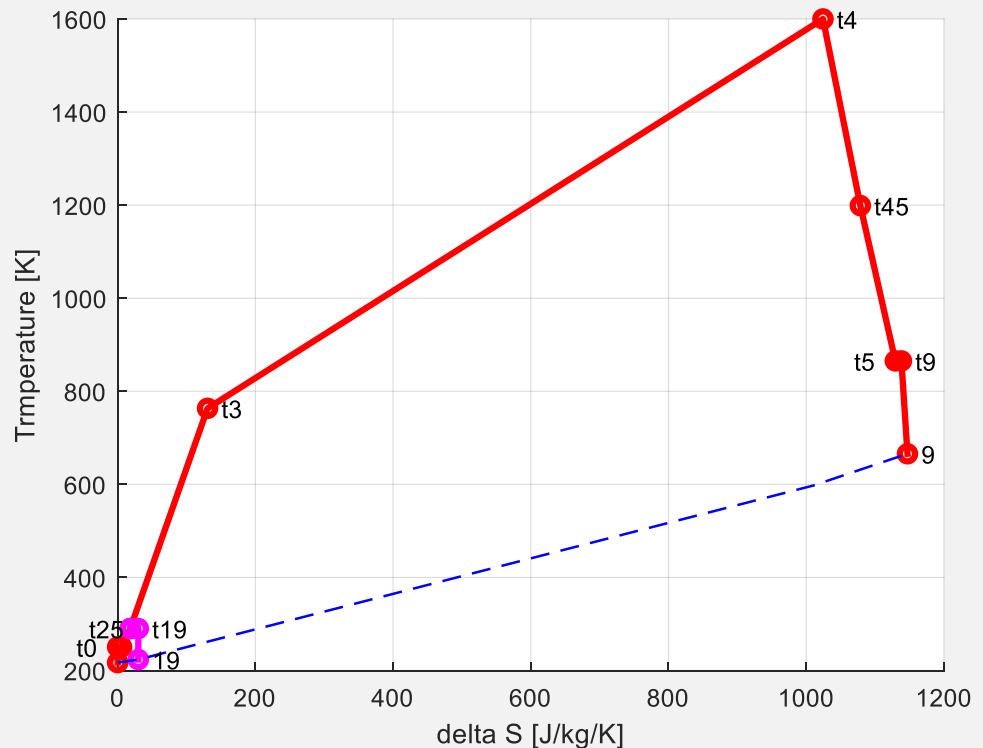
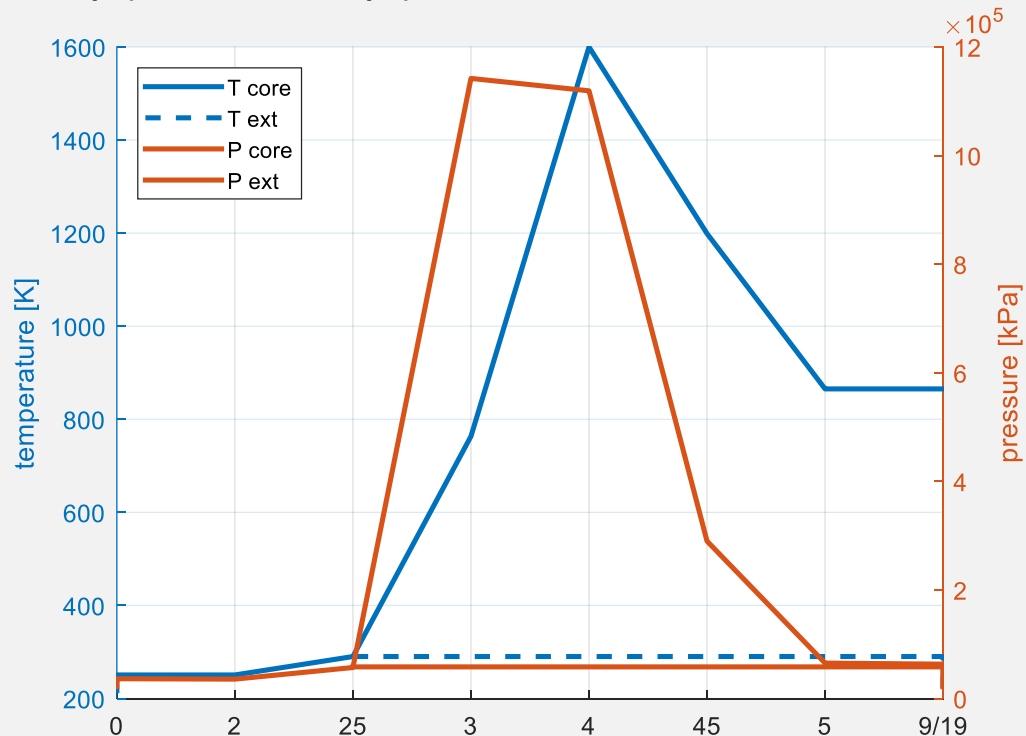

TURBOFAN ENGINE PERFORMANCE

	Parameter	Unit	Value
1	'Thrust'	'kN'	13.9345
2	'Specific Thrust'	'N*s/kg'	139.3452
3	'Fuel consumption'	'kg/s'	0.2382
4	'Specific fuel consump'	'kg/N/h'	0.0615
5	'therm. efficiency'	'.'	0.4915
6	'prop. efficiency'	'.'	0.7192
7	'overall efficiency'	'.'	0.3535
8	'V9'	'm/s'	682.8899
9	'V19'	'm/s'	365.8624
10	'HPT_PR'	'.'	3.8618
11	'LPT_PR'	'.'	4.4430

Results discussion:

- Specific thrust is significantly lower than in the turbjet engine
- Specific fuel consumption is lower than in the turbojet engine
- All efficiencies are higher than in the turbojet engine for specified flight condition

Link to example of turbofan engine calculation:

https://robert-jakubowski.v.prz.edu.pl/download/task_no_4_turbofan_engine.pdf

TURBOFAN ENGINE CYCLE OPTIMISATION

ST & SFC vs. HPC PR for constant BPR and FPR & three different TIT

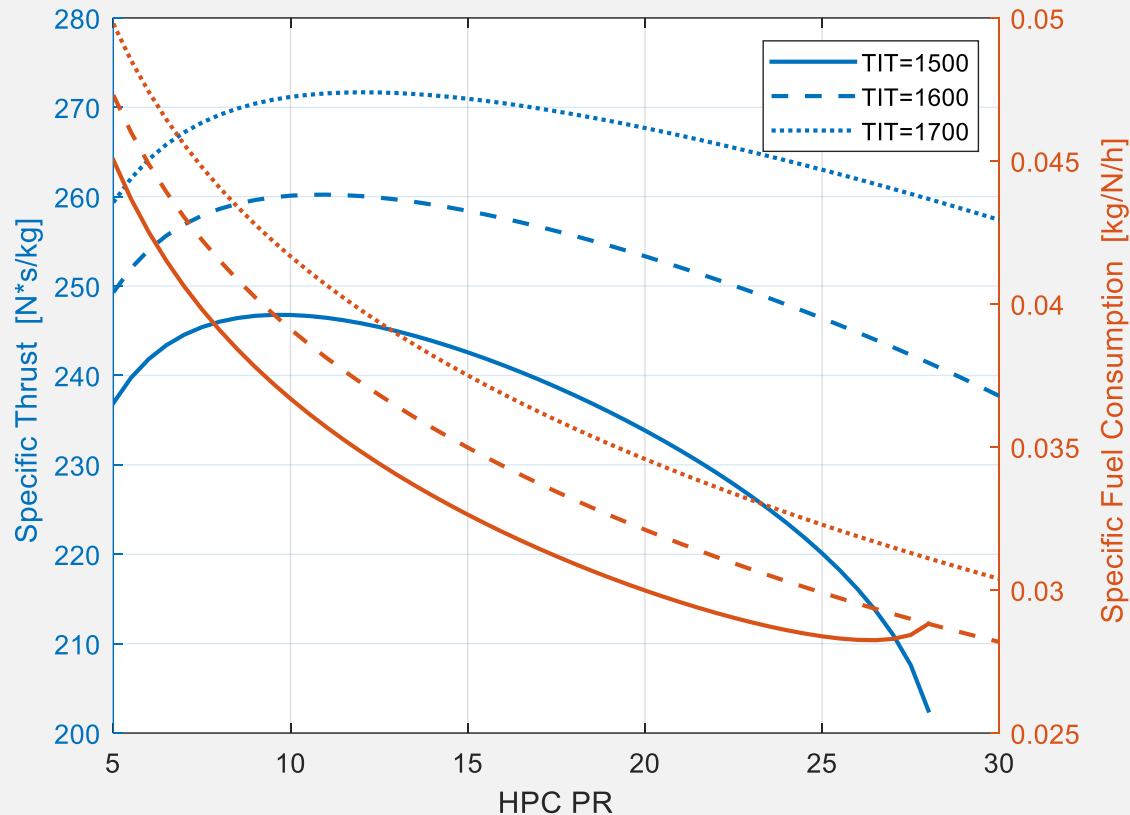

- ST initially grows, gets maximum for low HPC PR, then goes down
- SFC decreases and achieves minimum for high HPC PR then grows
- Higher TIT causes higher SFC & lower ST
- Higher BPR leads to PR distans grow between maximum ST and minimum SFC
- Presented dependencies are similar to turbojet engine

TURBOFAN ENGINE CYCLE OPTIMISATION

ST & SFC vs. HPC PR for constant TIT and FPR & three different BPR

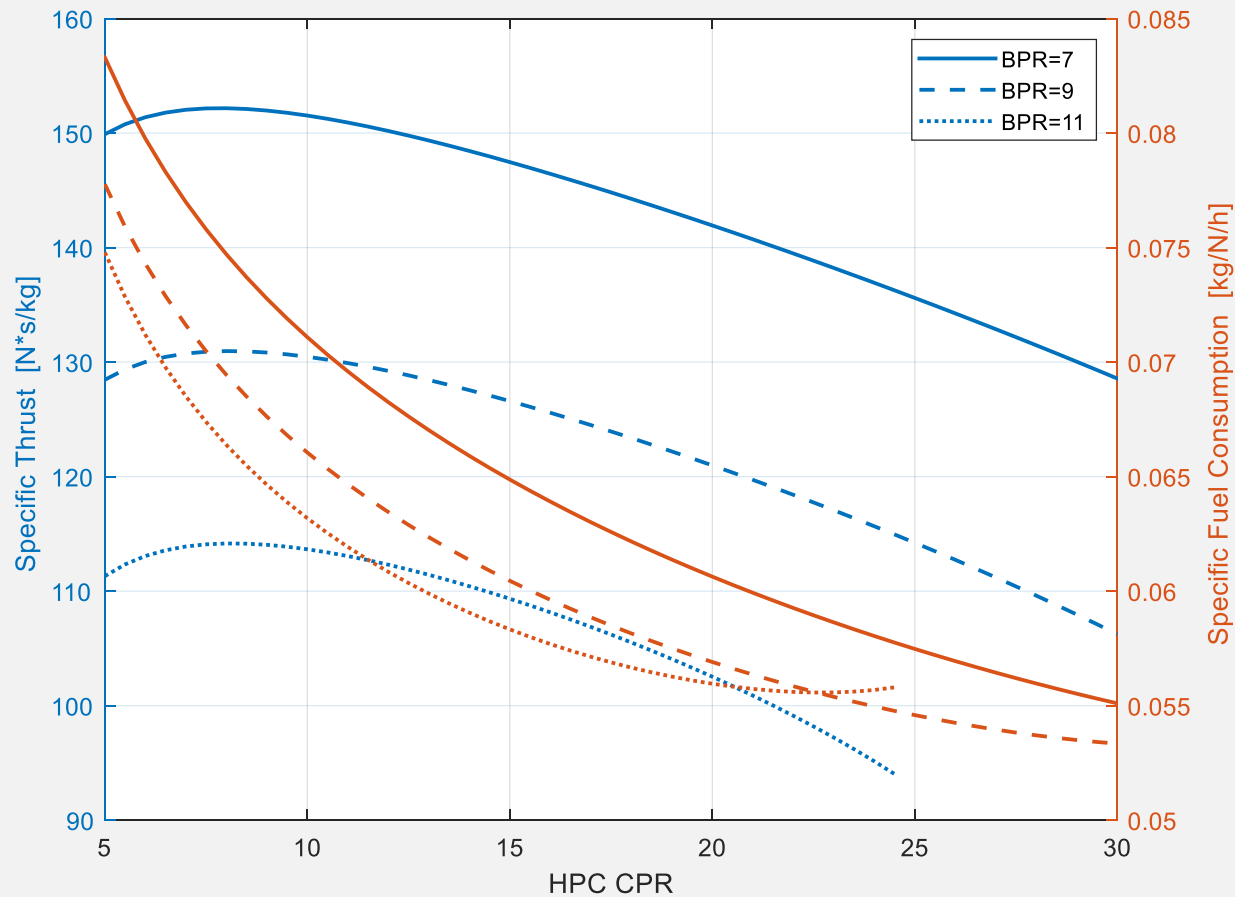

- ST initially grows, gets maximum for low HPC PR, then goes down
- SFC decreases and achieves minimum for high HPC PR then grows
- Higher BPR causes lower SFC & lower ST
- Higher BPR leads to less PR distans between maximum ST and minimum SFC

TURBOFAN ENGINE CYCLE OPTIMISATION

ST & SFC vs. FPR for constant TIT and FPR & three different BPR

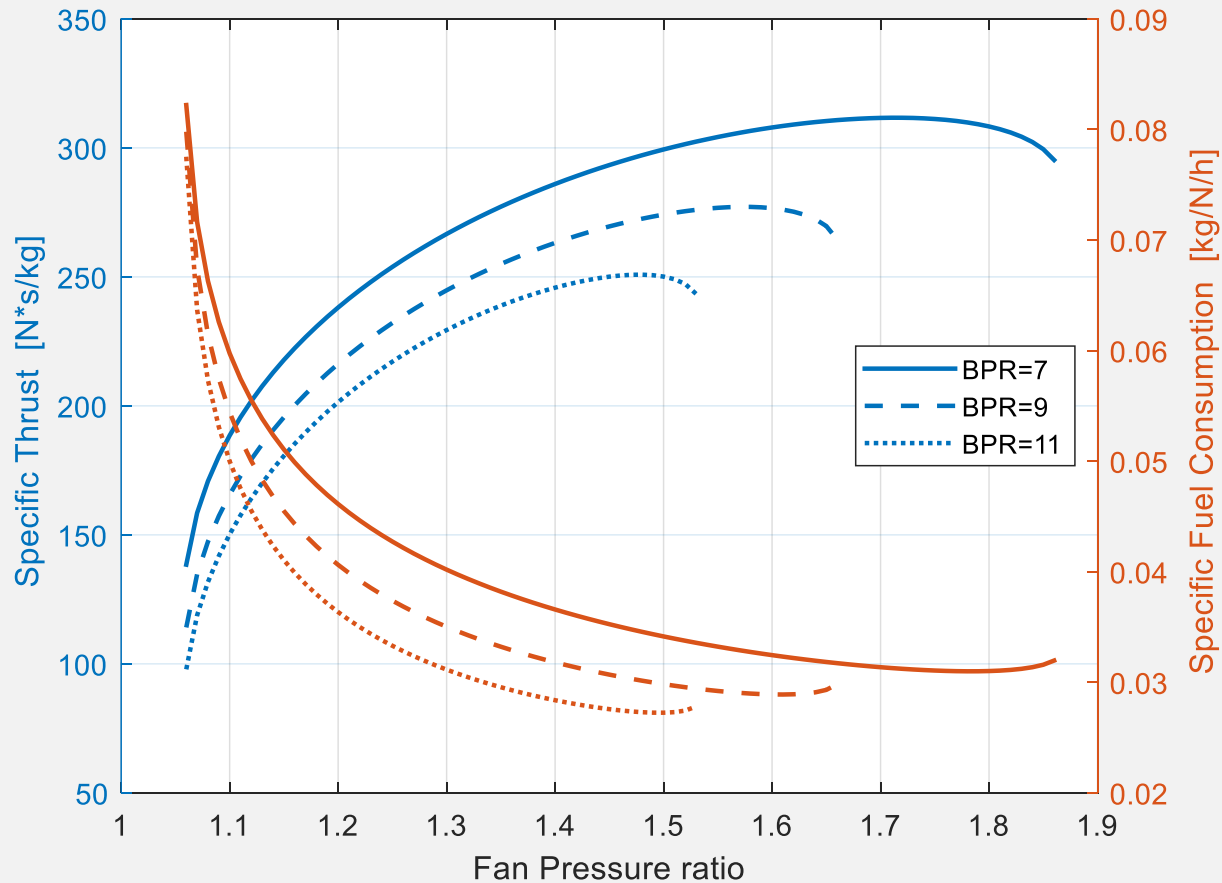

- ST gets maximum for the same FPR than SFC achieves minimum value.
- Lower BPR leads to FPR grow of maximum SF and minimum SFC
- It shows that it is possible to find optimal FPR for some BPR. FPR should be lower for higher BPR

THANKS FOR YOUR ATENTION

Questions and Comments ?

1.

2.

3.