

IDEAL TURBOJET

Robert Jakubowski PhD
Rzeszow University of Technology
Aerospace Engineering Department

LITERATURE:

- **Jack D. Mattingly, Elements of Propulsion: Gas Turbines and Rockets, AIAA Education Series 2006 (Chapter 5)**
- **Jack D. Mattingly, Elements of Gas Turbine Propulsion, Tata McGraw Hill Education Private Limited, 2013 (Chapter 5)**
- **Gordon C. Oates, Aerothermodynamics of Gas Turbine and Rocket Propulsion, AIAA Education Series, 1997 (Chapter 5)**

SECTION NUMBERING FOR GAS TURBINE ENGINE

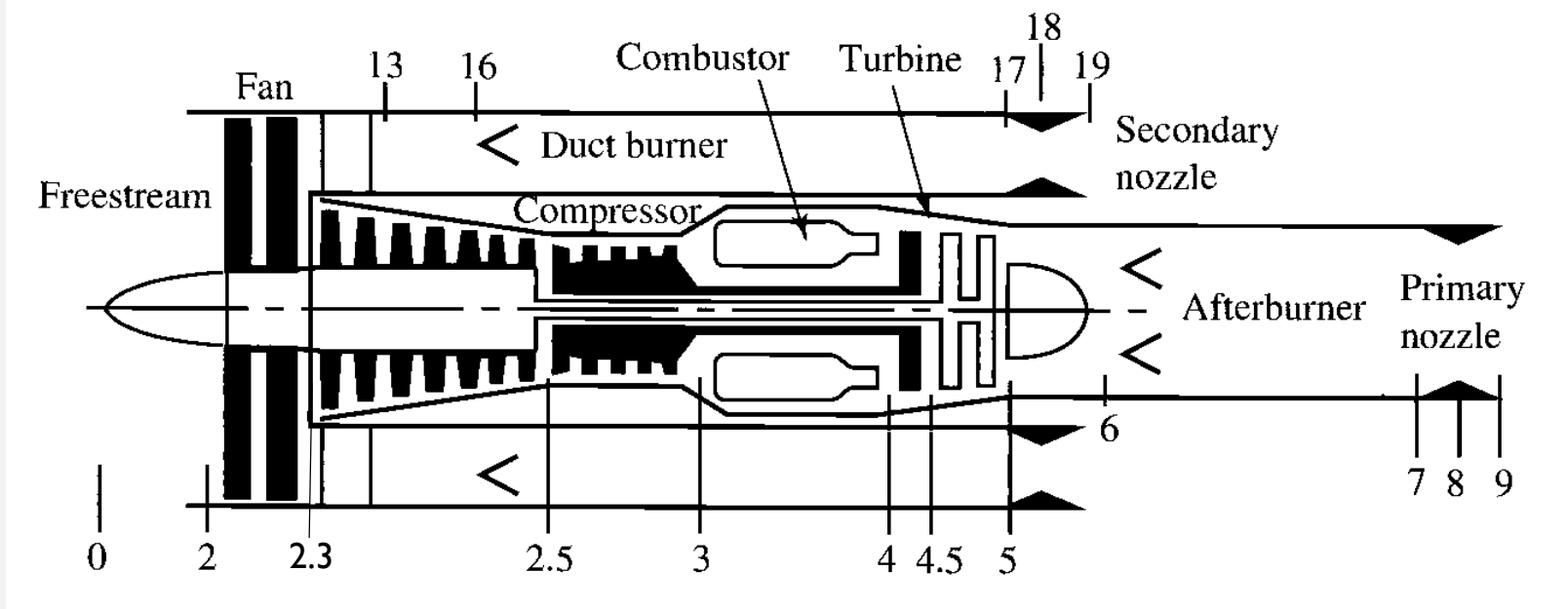

$$\pi_a = \frac{\text{total pressure leaving component a}}{\text{total pressure entering component a}}$$

$$\tau_a = \frac{\text{total temperature leaving component a}}{\text{total temperature entering component a}}$$

$$\pi_T = \frac{\text{total pressure entering turbine}}{\text{total pressure leaving turbine}} !$$

D/IN – Inlet diffuser (sections 0-2)

F – Fan (sections 2-13)

C – compressor (2-3)

LPC – Low Pressure Compressor (2.3-2.5)

HPC – High Pressure Compressor (2.5-3)

B – Burner/Combustor (3-4)

T – Turbine (4-5)

HPT – High Pressure Turbine (4-4.5)

LPT – Low Pressure Turbine (4.5-5)

AB – Afterburner (5-7)

N – Nozzle (7-9) (5-9)

ED – External Duct (13-17)

EN – External Nozzle (17-19) (13-19)

STATIC / TOTAL PARAMETERS

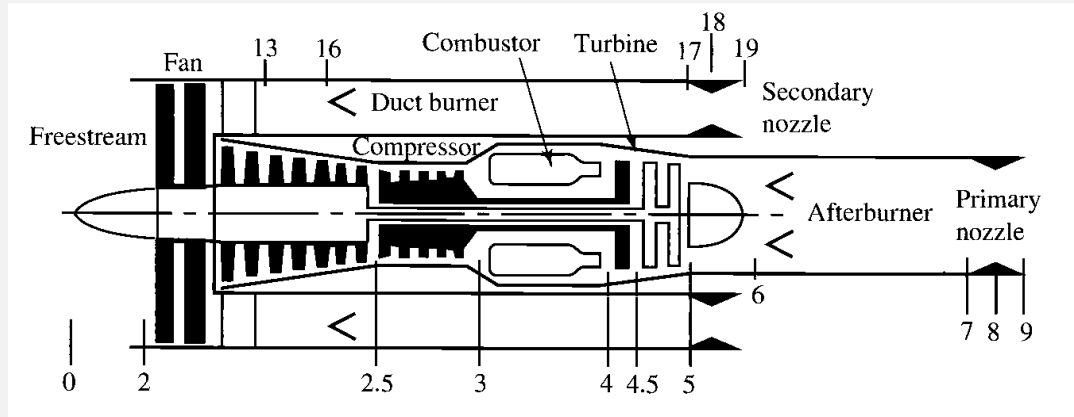

Ram pressure recovery for flight condition ($M_0 > 0$)

$$P_{t0} = P_0 \left(1 + \frac{k-1}{2} M_0^2 \right)^{k/(k-1)}$$

$$T_{t0} = T_0 \left(1 + \frac{k-1}{2} M_0^2 \right)$$

P_2 - static pressure in section 2

P_{t2} - total pressure in section 2

$$P_{t2} = P_2 \left(1 + \frac{k-1}{2} M_2^2 \right)^{k/(k-1)}$$

T_2 - static temperature in section 2

T_{t2} - total temperature in section 2

$$T_{t2} = T_2 \left(1 + \frac{k-1}{2} M_2^2 \right)$$

For IDEAL ENGINE losses are omitted

$$\pi_D = \pi_B = \pi_N = \pi_{EN} = 1$$

Additional assumption:

Perfect gas:

$C_p = 1005$ J/kg/K, $k = 1.4$, $R = 287$ J/kg/K – for air

$C_{pt} = 1170$ J/kg/K, $k_t = 1.33$, $R = 290$ J/kg/K – for fume

$C_{pB} = 1200$ J/kg/K

$C_{pAB} = 1250$ J/kg/K

IDEAL RAMJET

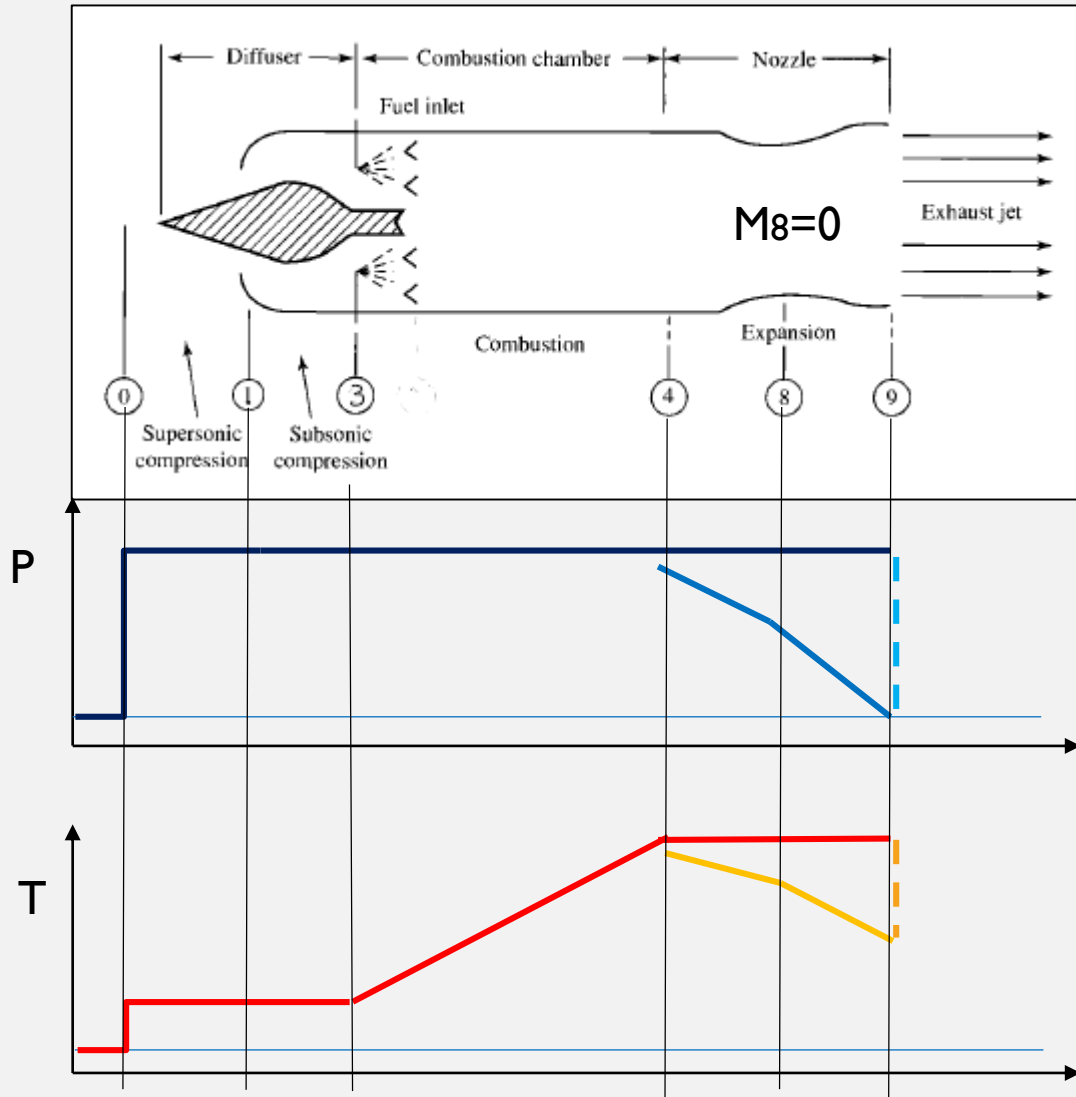

Air compression is provided in diffuser for $V_0 > 1$

Ram pressure recovery for flight condition ($M_0 > 0$)

$$P_{t0} = P_0 \left(1 + \frac{k-1}{2} M_0^2 \right)^{k/(k-1)}$$

where: $M_0 = \frac{V_0}{\sqrt{k \cdot R \cdot T_0}}$

$$T_{t0} = T_0 \left(1 + \frac{k-1}{2} M_0^2 \right)$$

No diffuser losses

$$\pi_D = 1, \tau_D = 1, \quad P_{t3} = P_{t1} = P_{t0} \quad T_{t3} = T_{t1} = T_{t0}$$

Ideal combustion process for specific T_{t4} , $\pi_B = 1$

$$P_{t4} = \pi_B P_{t3} \quad f * FHV = C p_B (T_{t4} - T_{t3}),$$

$f = \dot{m}_f / \dot{m}_0$ - Fuel air ratio

Ideal nozzle expansion $\pi_N = 1, \tau_N = 1,$

$$P_{t9} = P_{t4} \quad T_{t9} = T_{t4} \quad P_9 = P_0 \quad T_9 = T_{9t} (P_9 / P_{9t})^{(kt-1)/kt}$$

IDEAL RAMJET – THERMODYNAMIC CYCLE

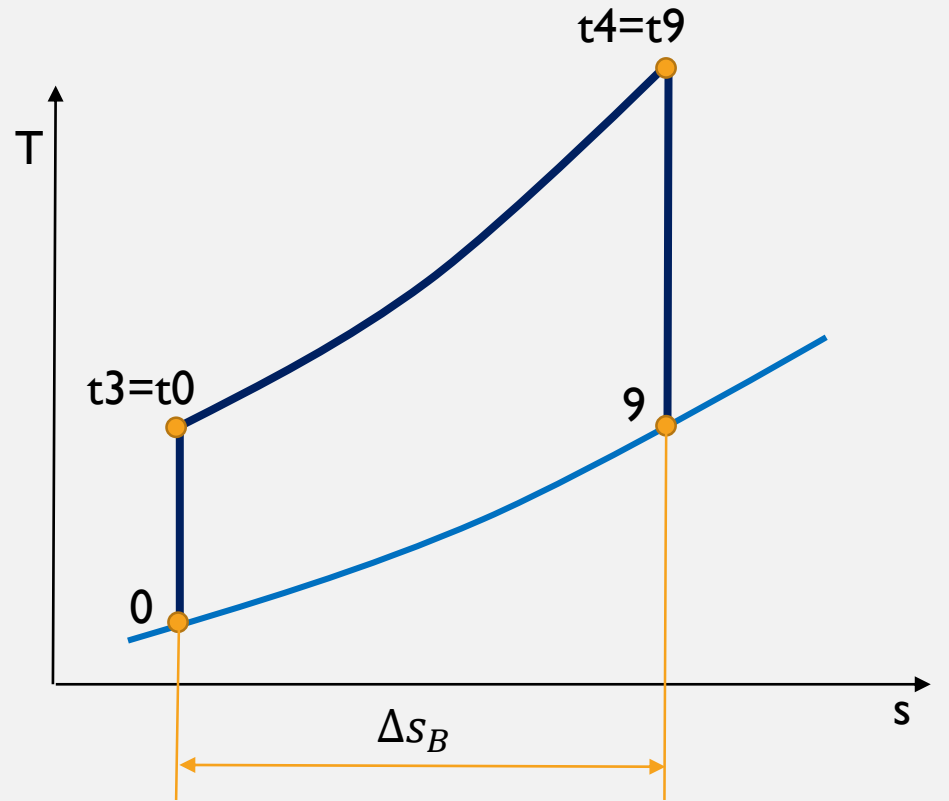
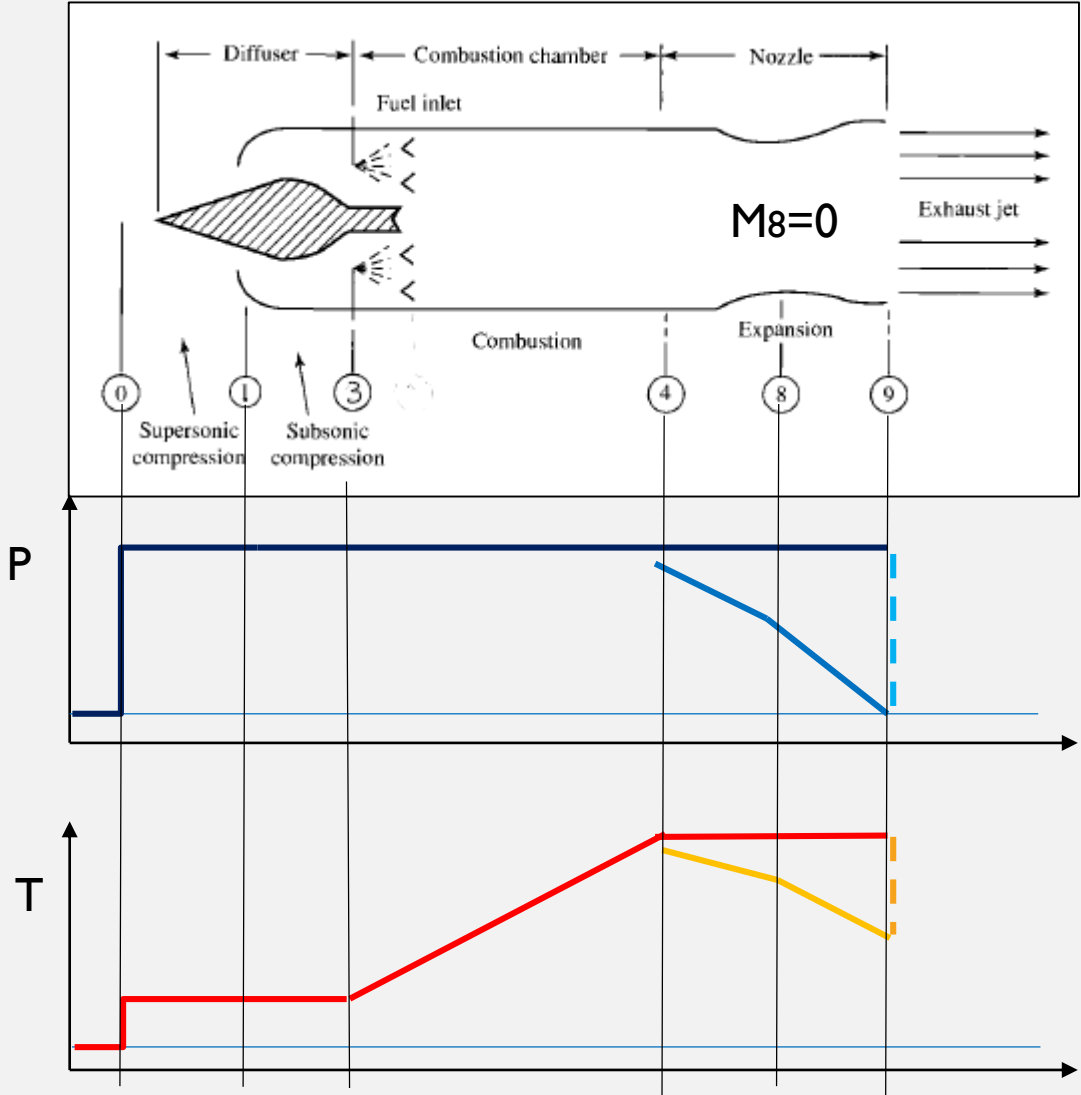

Entropy increase in a burner

$$\Delta s_B = c_{p_B} \ln \frac{T_{t4}}{T_{t3}}$$

IDEAL RAMJET CYCLE PARAMETERS CALCULATION

Propelling nozzle outlet gas speed c_9

$$c_9 = \sqrt{2Cp_t(T_{9t} - T_9)} \quad - \text{ for incompressible flow}$$

$$c_9 = a_9 M_9 = \sqrt{k_t R_t T_9} * \sqrt{\frac{2}{k_t - 1} \left(\frac{T_{t9}}{T_9} - 1 \right)} \quad - \text{ for compressible flow}$$

CYCLE PARAMETERS CALCULATION AND ENGINE PERFORMANCE PARAMETERS
are presented in: [Ideal ramjet example.pdf](#)

IDEAL RAMJET PERFORMANCE - THRUST

Calculation done for $H=11$ km, $\dot{m}_0=20$ kg/s and $T_{t4}=1000, 1200, 1500$ K; $T = \dot{m}_9 V_9 - \dot{m}_0 V_0$; $ST = T/\dot{m}_0$

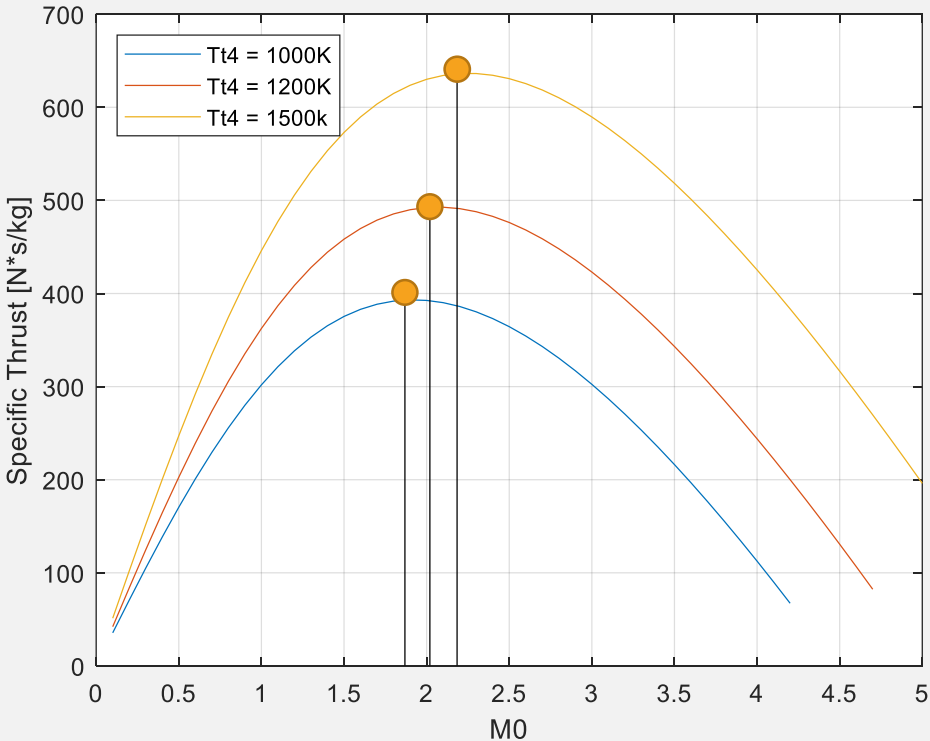
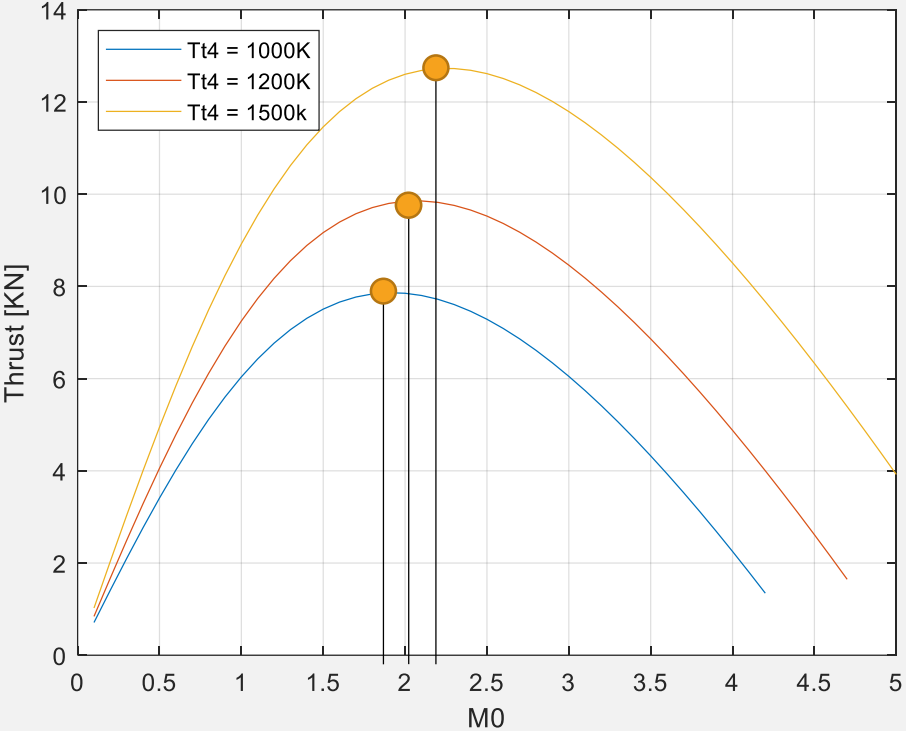

- Ramjet engine thrust increases to its maximum with flight speed and then decreases.
- Specific thrust vs flight speed relation looks similar
- For higher T_{t4} thrust is higher and reaches its maximum value for higher flight speed.

IDEAL RAMJET PERFORMANCE - SFC

Calculation done for $H=11$ km, $m_0=20$ kg/s and $T_{t4}=1000, 1200, 1500$ K; $SFC = f/ST$

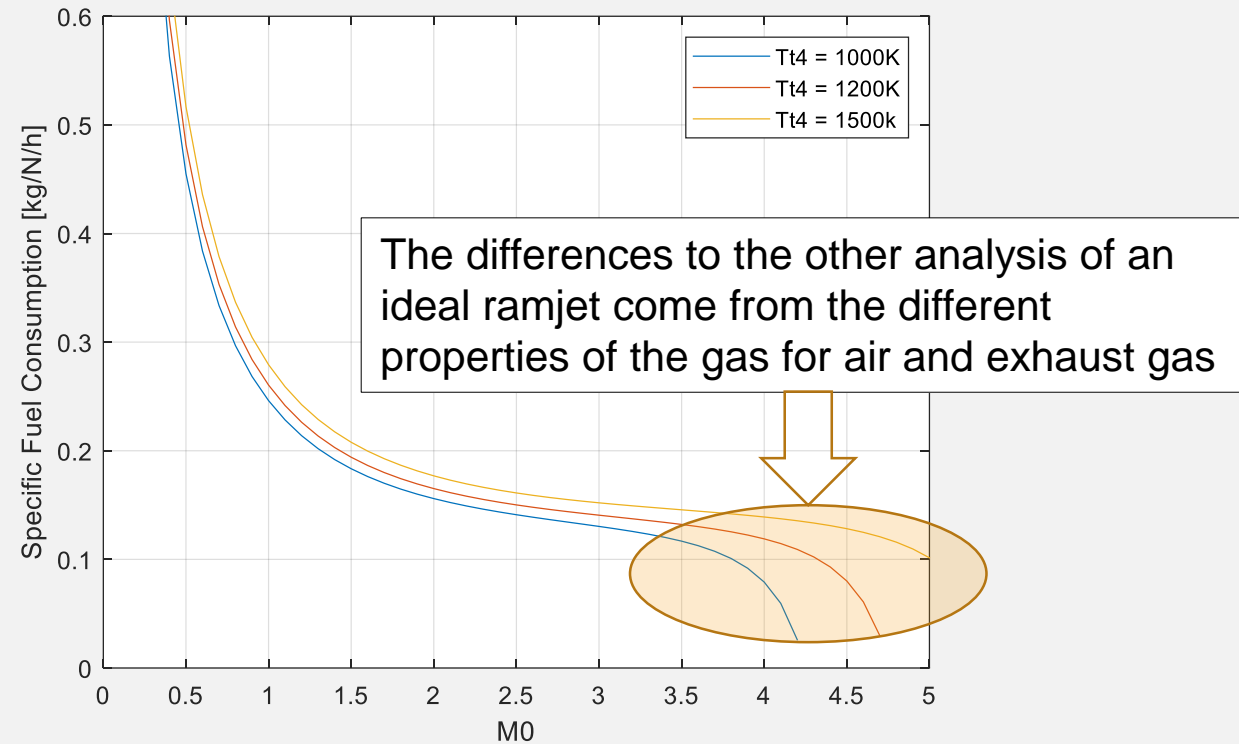
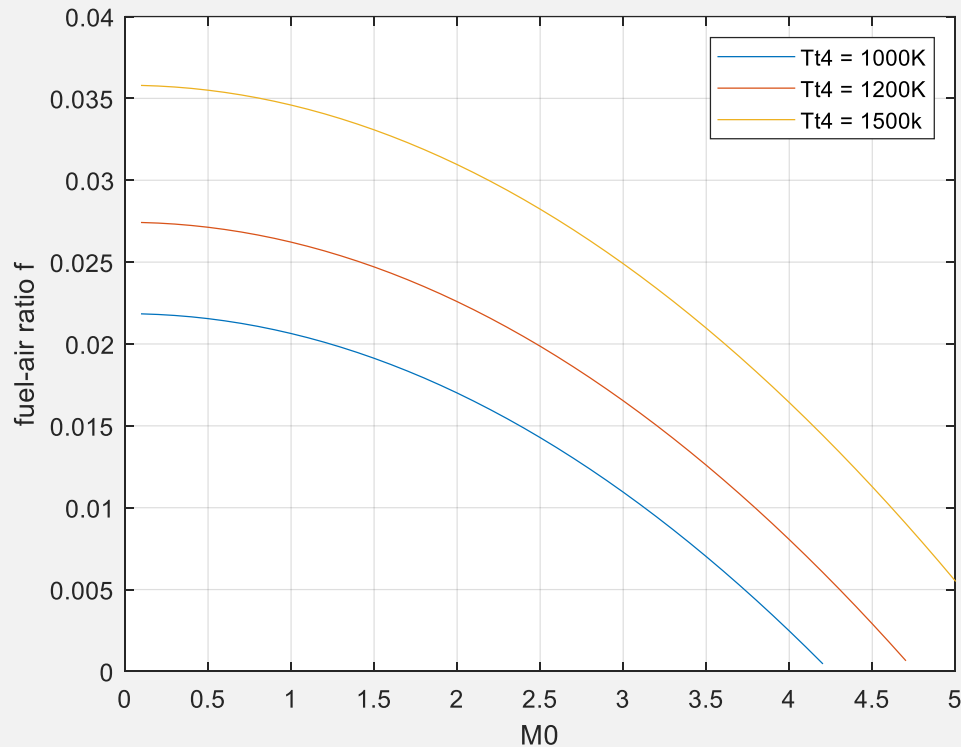

- The fuel to air ratio goes down with flight speed.
- The fuel to air ratio is lower for the lower T_{t4} .
- The range of flight speed applicability is lower when T_{t4} is lower (the end of range when f reaches 0)
- SFC goes down for higher flight speed

IDEAL RAMJET PERFORMANCE - EFFICIENCIES

Calculation done for $H=11$ km, $m_0=20$ kg/s and $T_{t4}=1000, 1200, 1500$ K;

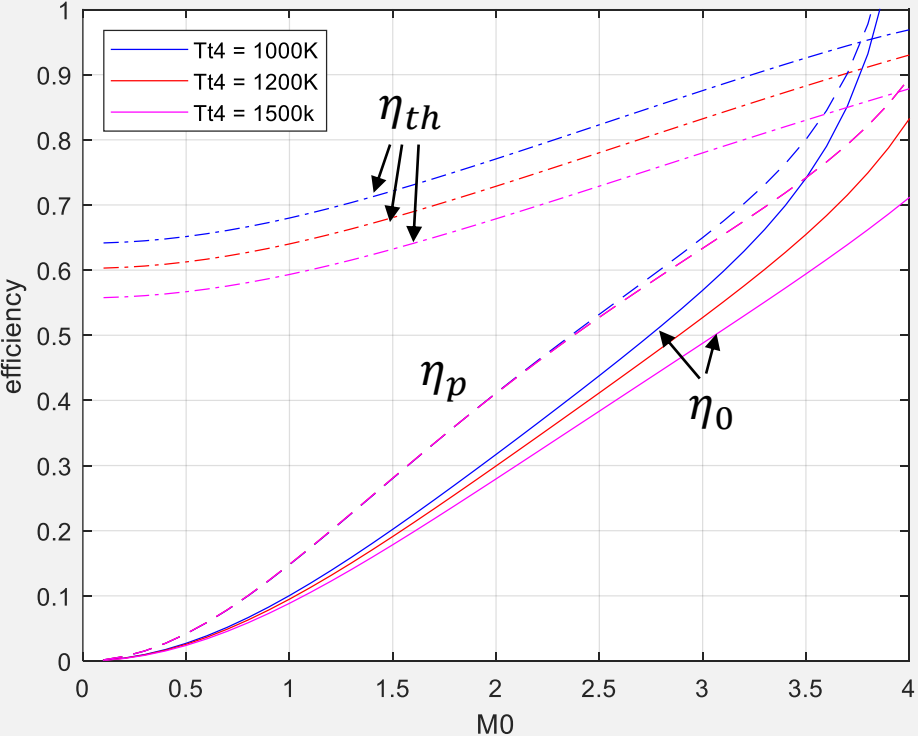

Thermal, propulsive and overall efficiency of ideal ramjet grow with flight speed
Thermal efficiency depends on flight speed only (T_{t4} doesn't influence on it). For higher Ma thermal efficiency for $T_{t4}=1000$ K is different than for higher T_{t4} s due to other air and exhaust gas parameters
Propulsive and overall efficiencies depend on flight speed and T_{t4} , and for higher T_{t4} they are lower.

IDEAL TURBOJET ENGINE

Engine work in static conditions $V_0=0 \rightarrow P_{t0} = P_0, T_{t0} = T_0$

Ram pressure recovery for flight condition ($M_0 > 0$)

$$P_{t0} = P_0 \left(1 + \frac{k-1}{2} M_0^2 \right)^{k/(k-1)} \quad T_{t0} = T_0 \left(1 + \frac{k-1}{2} M_0^2 \right)$$

No **INLET** losses $\rightarrow P_{t2} = P_{t0}$ and $T_{t2} = T_{t0}$

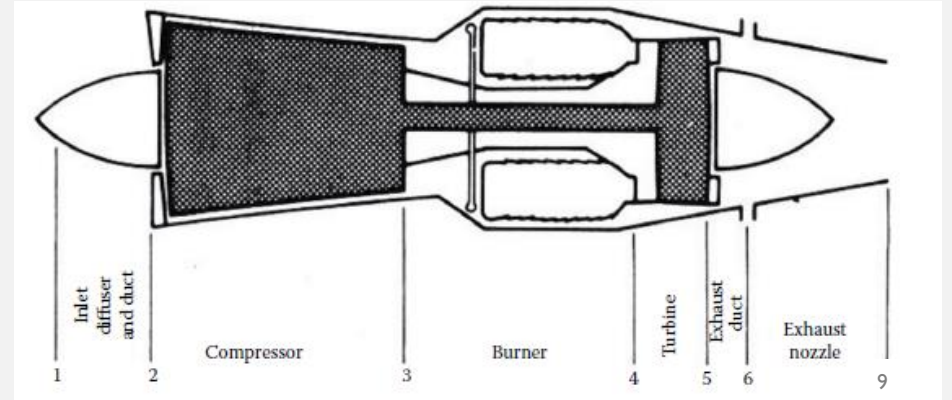

COMPRESSOR (2 - 3)

Compressor work is isentropic

$$\frac{T_{t3}}{T_{t2}} = \left(\frac{P_{t3}}{P_{t2}} \right)^{(k-1)/k} = \pi_C^{(k-1)/k}$$

Compressor work:

$$W_C = Cp(T_{t3} - T_{t2})$$

Compressor power:

$$P_C = \dot{m}_C W_C = \dot{m}_0 Cp(T_{t3} - T_{t2})$$

COMBUSTOR (3 - 4)

Energy balance

$$\dot{m}_f FHV = \dot{m}_0 Cp_B (T_{t4} - T_{t3})$$

$$\dot{m}_f = \frac{\dot{m}_0 Cp_B (T_{t4} - T_{t3})}{FHV}$$

Fuel air ratio:

$$f = \frac{\dot{m}_f}{\dot{m}_0} = \frac{Cp_B (T_{t4} - T_{t3})}{FHV}$$

$$\pi_B = 1 \rightarrow P_{t4} = P_{t3}$$

TURBINE (4 - 5)

Compressor turbine power balance equation

$$P_C = \dot{m}_0 Cp (T_{t3} - T_{t2}) = P_T = \dot{m}_T Cp_T (T_{t4} - T_{t5})$$

Turbine mass flow: $\dot{m}_T = \dot{m}_0 + \dot{m}_f$

Turbine outlet temperature:

$$T_{t5} = T_{t4} - \frac{Cp (T_{t3} - T_{t2})}{Cp_T (1 + f)}$$

Turbine outlet pressure:

$$P_{t5} = P_{t4} \left(\frac{T_{t5}}{T_{t4}} \right)^{k_t/(k_t-1)}$$

IDEAL TURBOJET ENGINE – GASS FULL EXPANSION IN THE NOZZLE

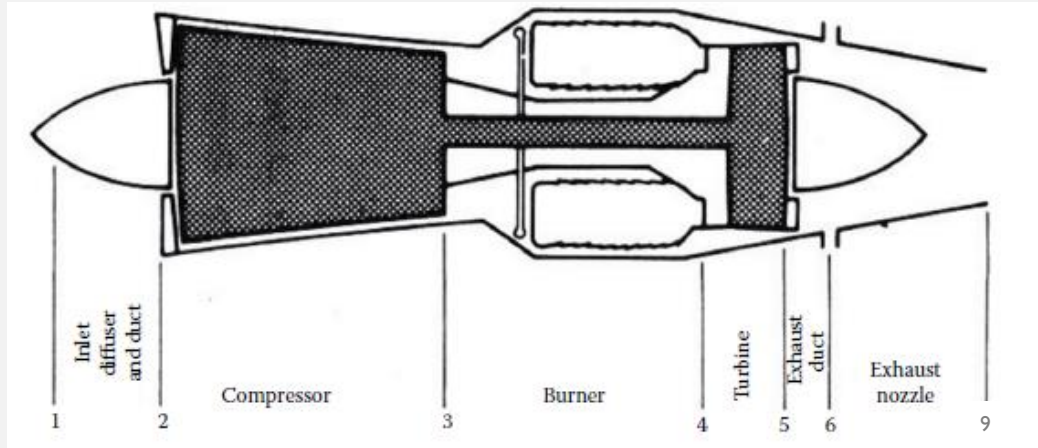

NOZZLE (5-9)

No losses: $\pi_N = 1 \rightarrow P_{t9} = P_{t5}$ and $T_{t9} = T_{t5}$

Full expansion: $P_9 = P_0$

$$c_9 = \sqrt{2Cp_t(T_{9t} - T_9)} \quad \text{- for incompressible flow}$$

$$c_9 = a_9 M_9 = \sqrt{k_t R_t T_9} * \sqrt{\frac{2}{k_t - 1} \left(\frac{T_{t9}}{T_9} - 1 \right)} \quad \text{- for compressible flow}$$

$$\frac{T_{t9}}{T_9} = \frac{P_{t9}^{(k_t-1)/k_t}}{P_9}$$

IDEAL TURBOJET ENGINE

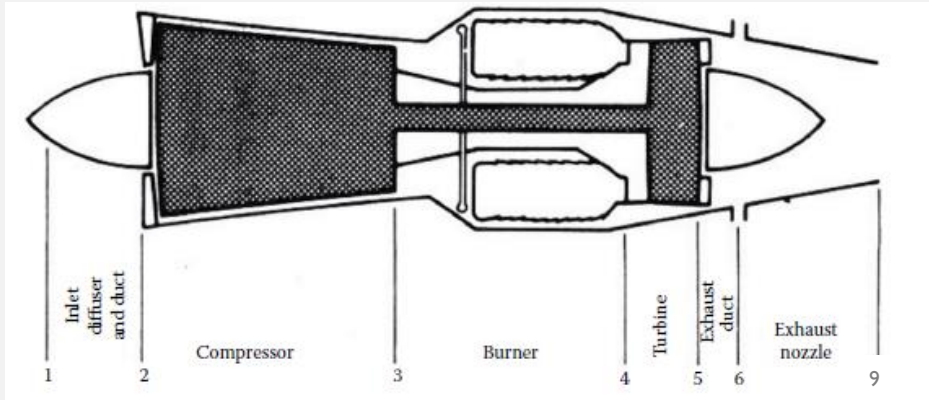

Processes in the inlet (diffuser) burner and nozzle are ideal – no pressure losses $\pi_D = \pi_B = \pi_N = 1$

Static condition $V_0=0$

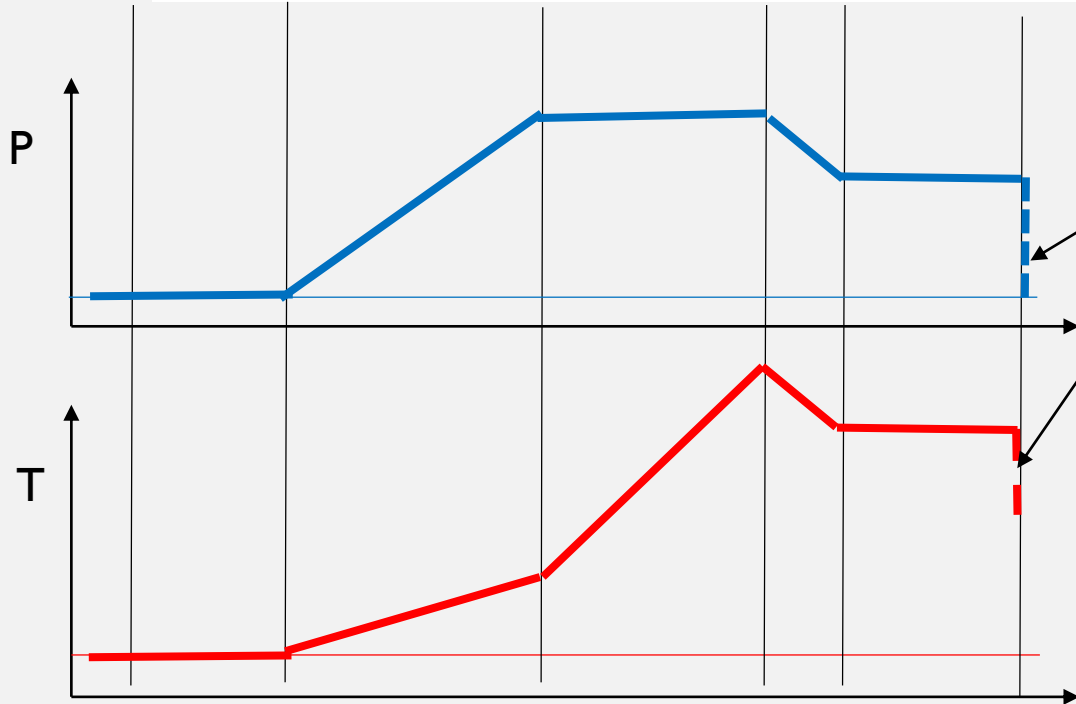

total to static process

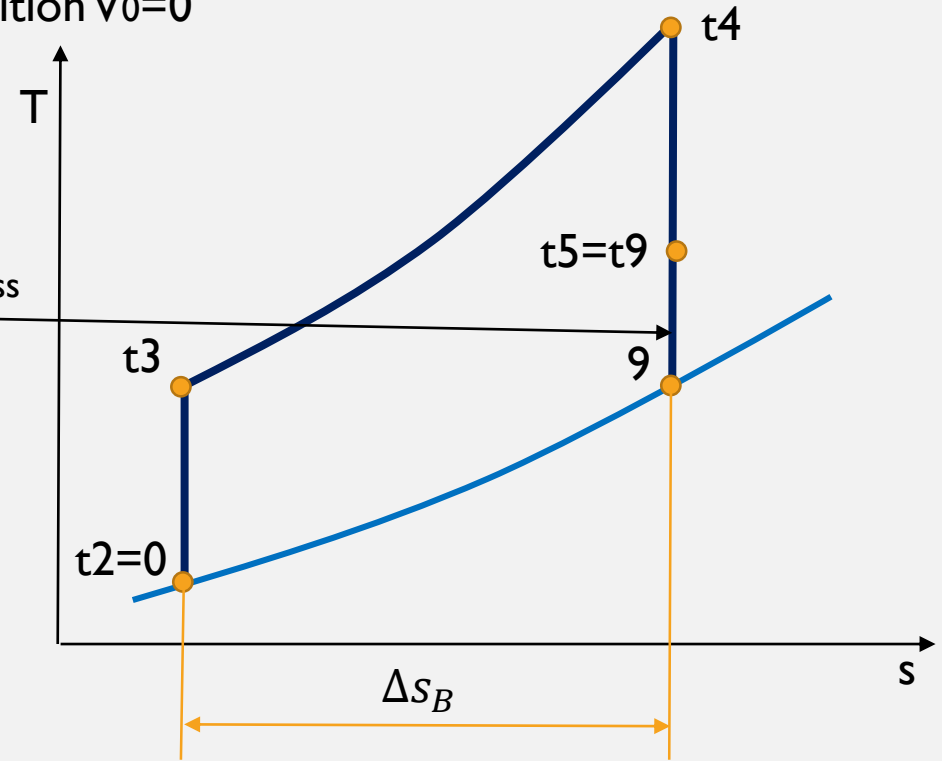

Entropy increase in a burner $\Delta s_B = c_{p_B} \ln \frac{T_{t4}}{T_{t3}}$

IDEAL TURBOJET ENGINE

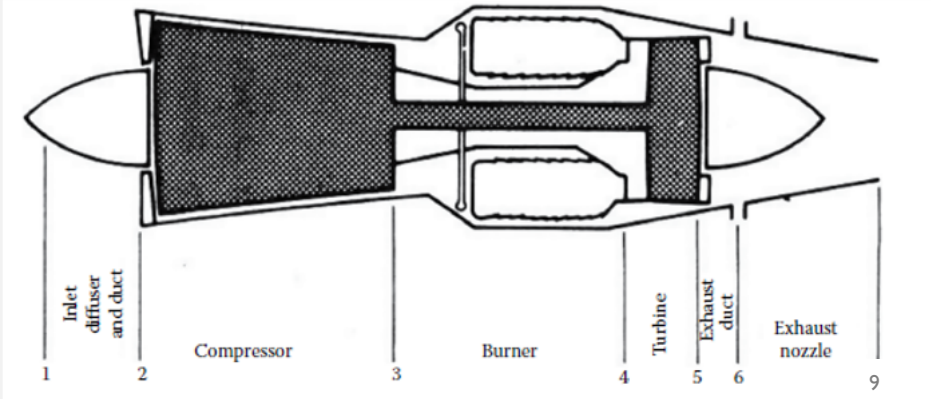

Flight condition $V_0 > 0$

$$P_{t0} = P_0 \left(1 + \frac{k-1}{2} M_0^2 \right)^{k/(k-1)}$$

$$T_{t0} = T_0 \left(1 + \frac{k-1}{2} M_0^2 \right)$$

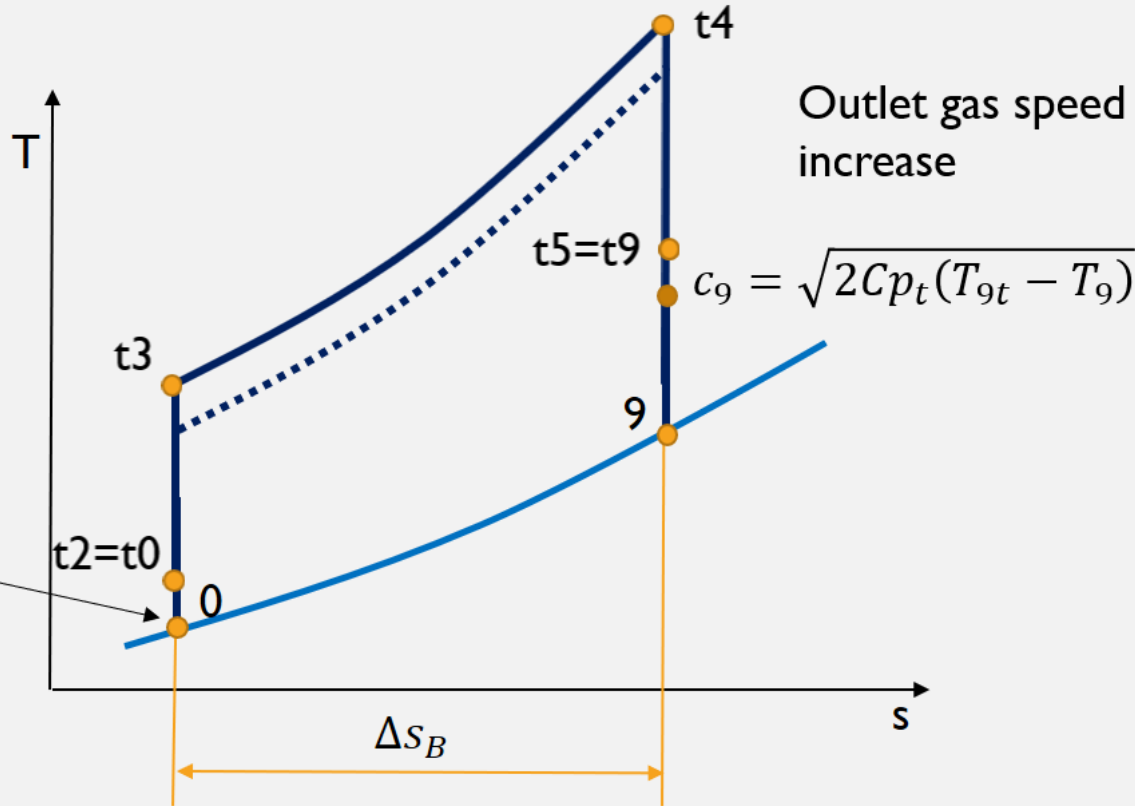
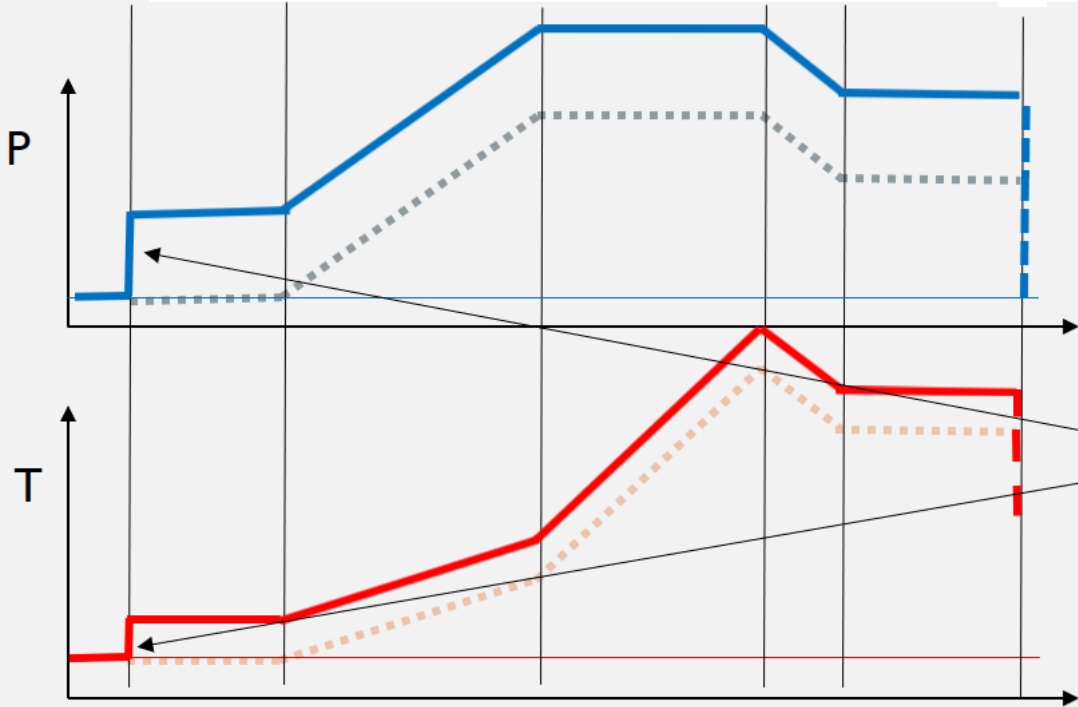

IDEAL TURBOJET ENGINE – FLIGHT SPEED INFLUENCE

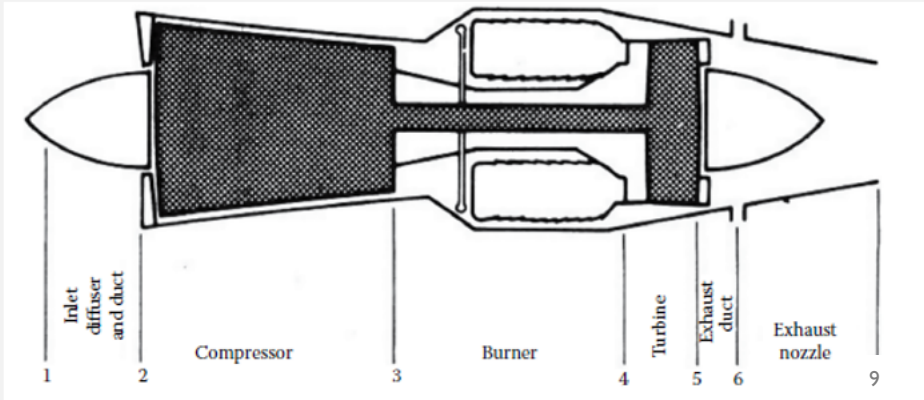

Flight condition $V_0 > 0$ and T_{t4} limit T_{t4_max}

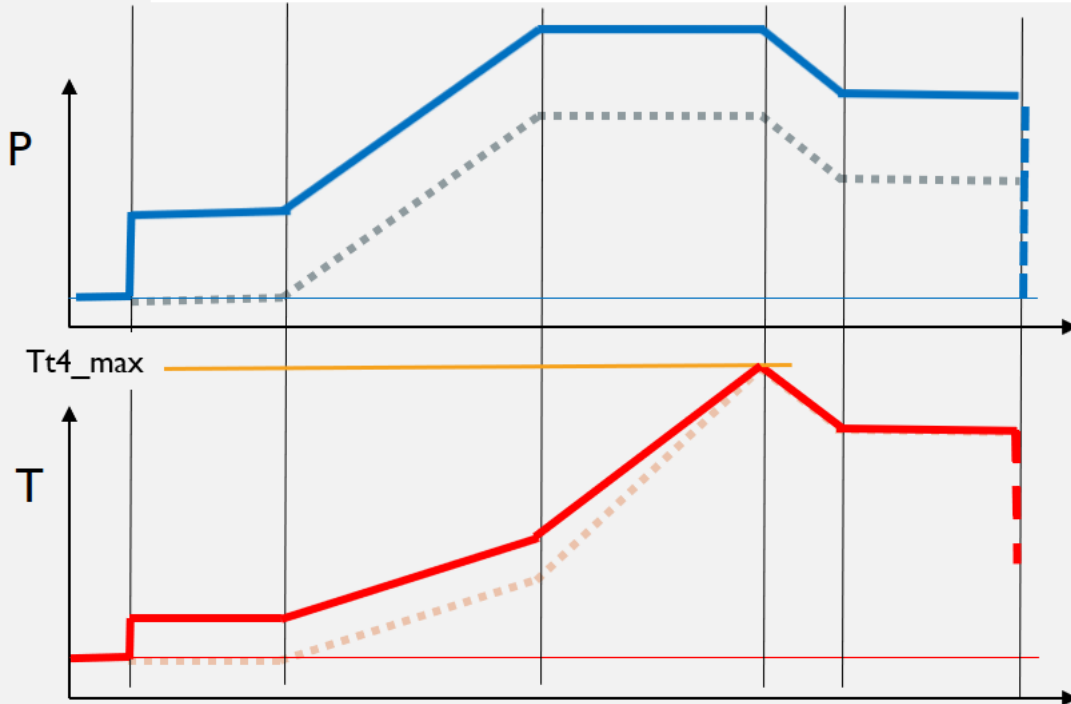

Less heat added

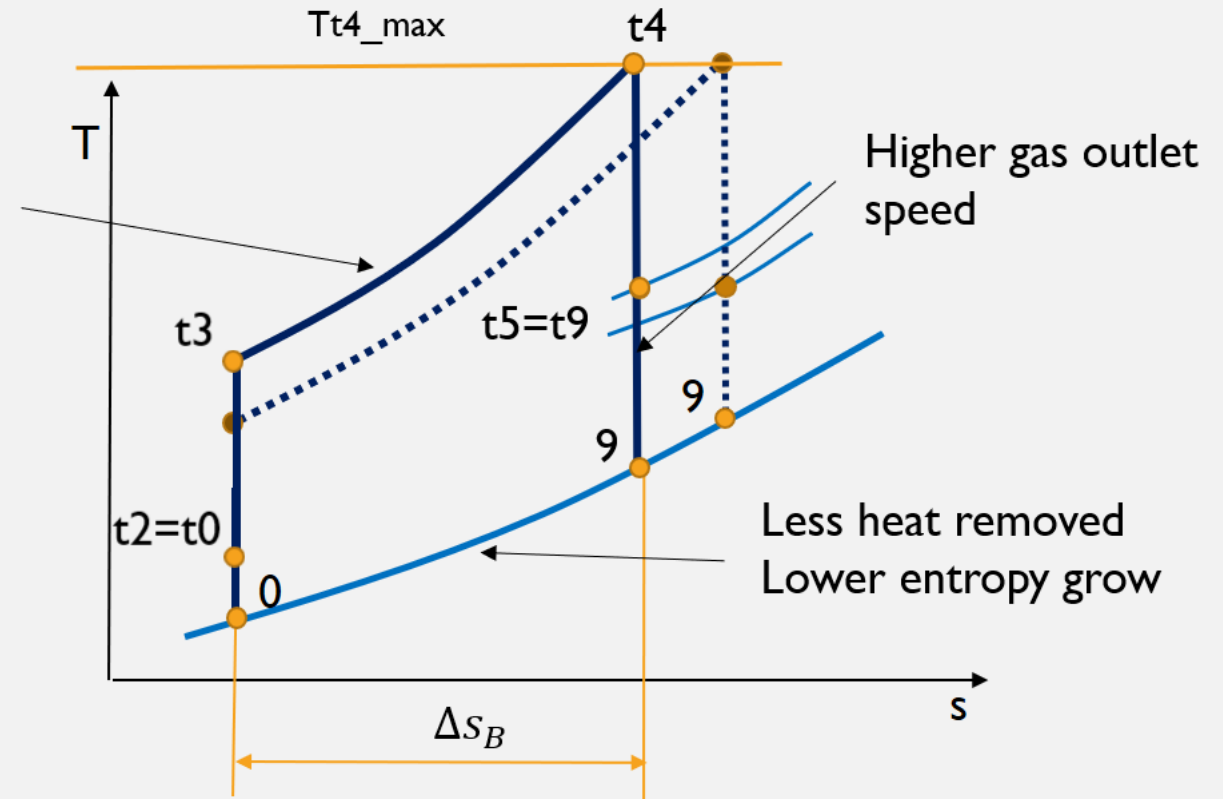

**Engine thermal efficiency grow (less heat removed)
Lower fuel consumption (less heat added)**

IDEAL TURBOJET ENGINE – COMPRESSOR PRESSURE RATIO INFLUENCE

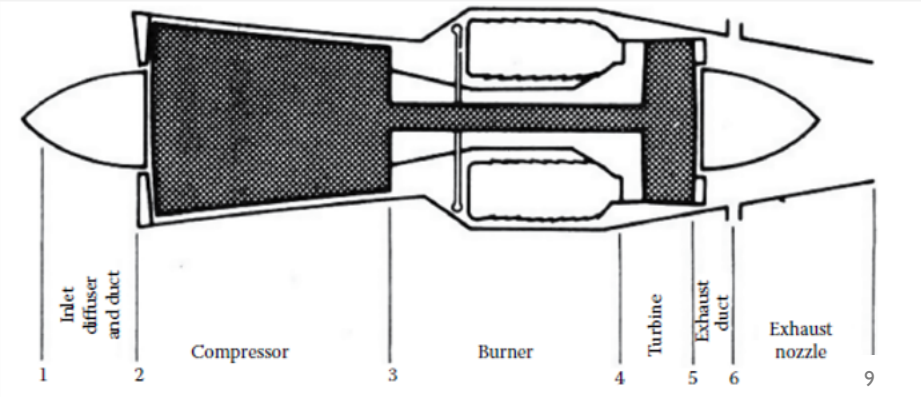

CPR (compressor pressure ratio) growing and T_{t4} is limited T_{t4_max}

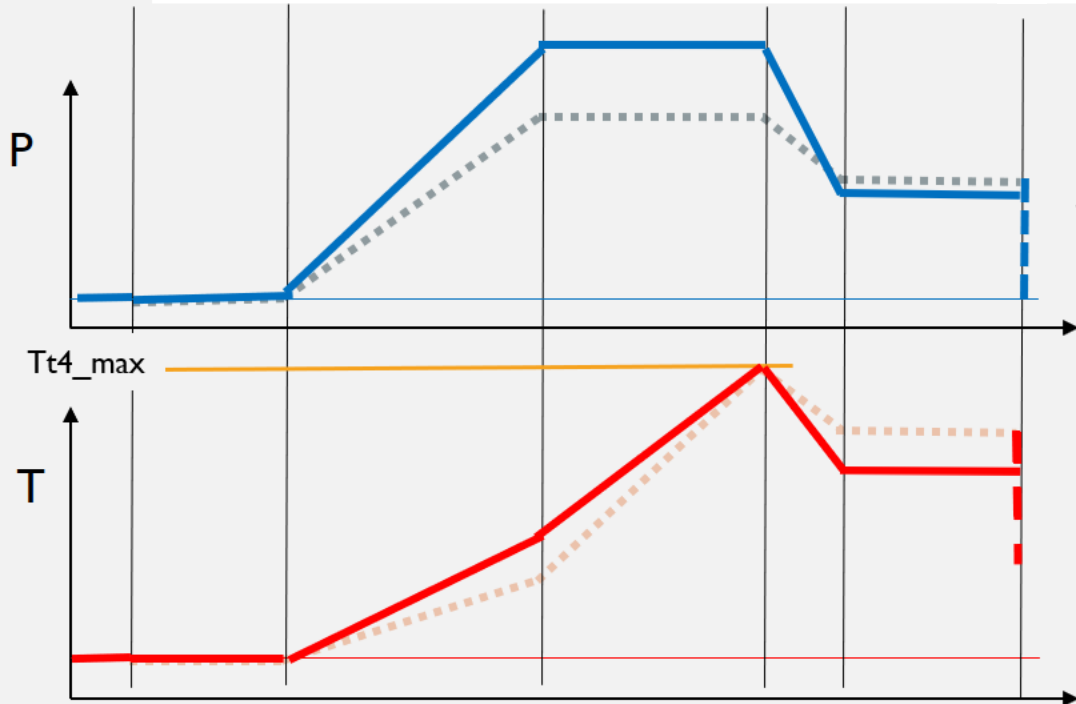

Less heat added

Higher compressor work

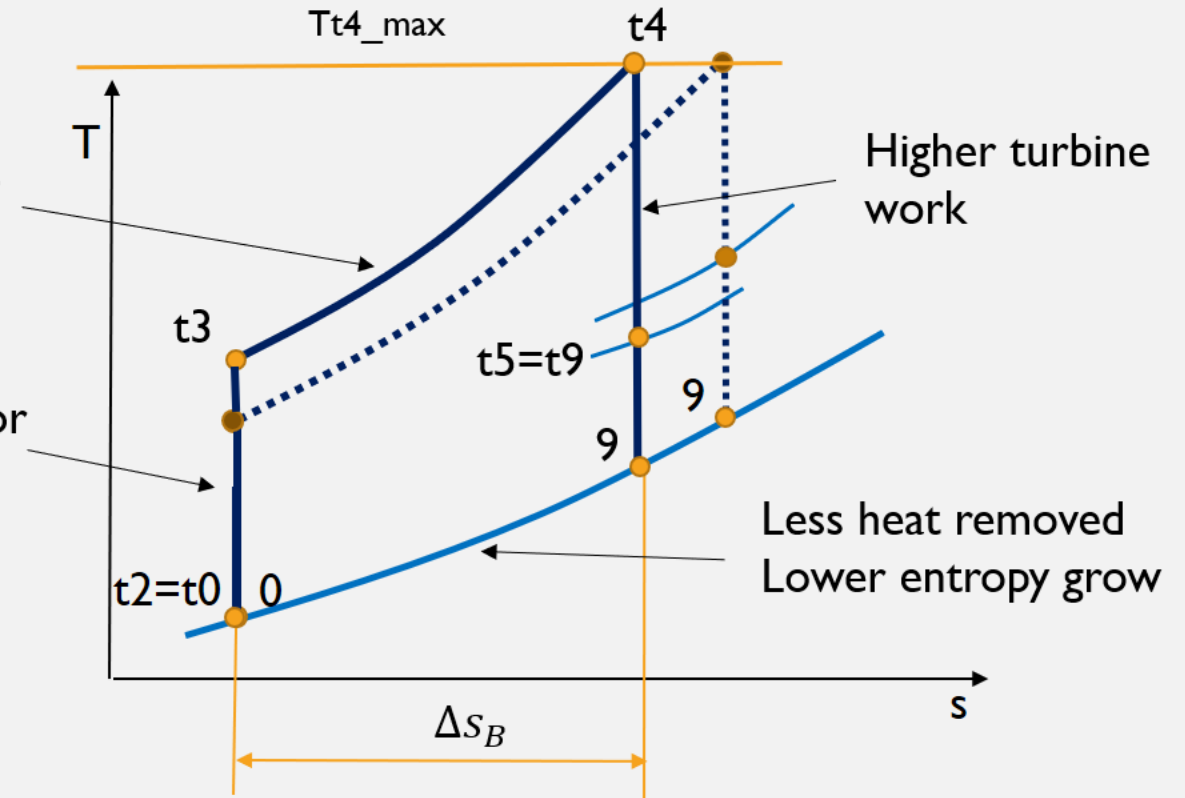

**Engine thermal efficiency grow (less heat removed)
Lower fuel consumption (less heat added) and lower SFC**

IDEAL TURBOJET CYCLE OPTIMISATION

SUMMARY:

- Specific thrust (ST) grows with compressor pressure ratio increasing, achieves maximum for optimal CPR than is goes down
- Specific fuel consumption decreases with CPR growing
- Propulsive efficiency as a function of CPR represents oposit relation to ST, it is minimal for optimal CPR and achieves 1 for ST=0.
- Thermal and overall efficiencies grow with CPR
- The presented relationship between efficiencies and CPR are right for $M_0 > 0$, for $M_0 = 0$, propulsive and overall efficiency are 0

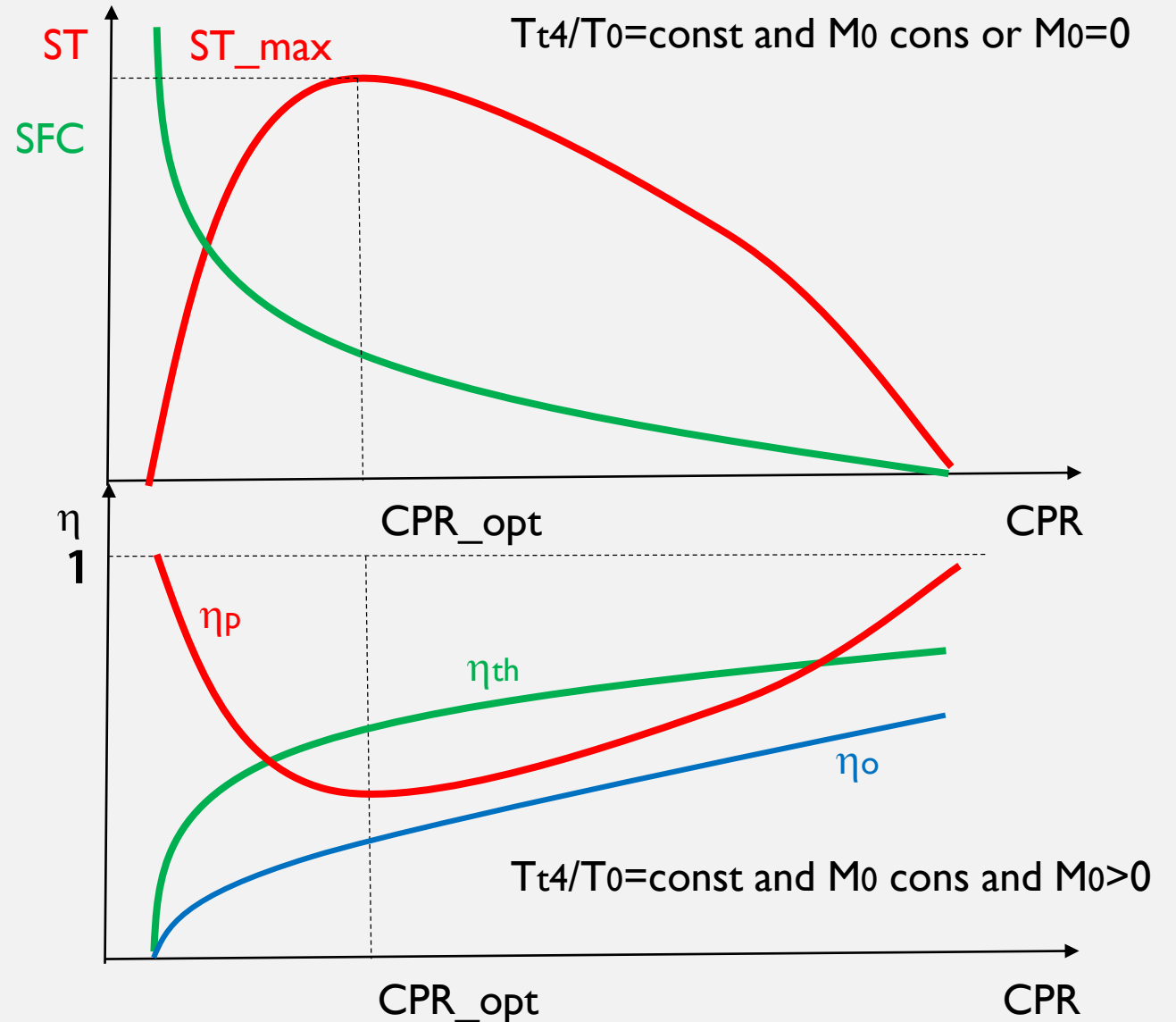

IDEAL TURBOJET CYCLE OPTIMISATION FOR DIFFERENT ENGINE TEMPERATURE RATIO

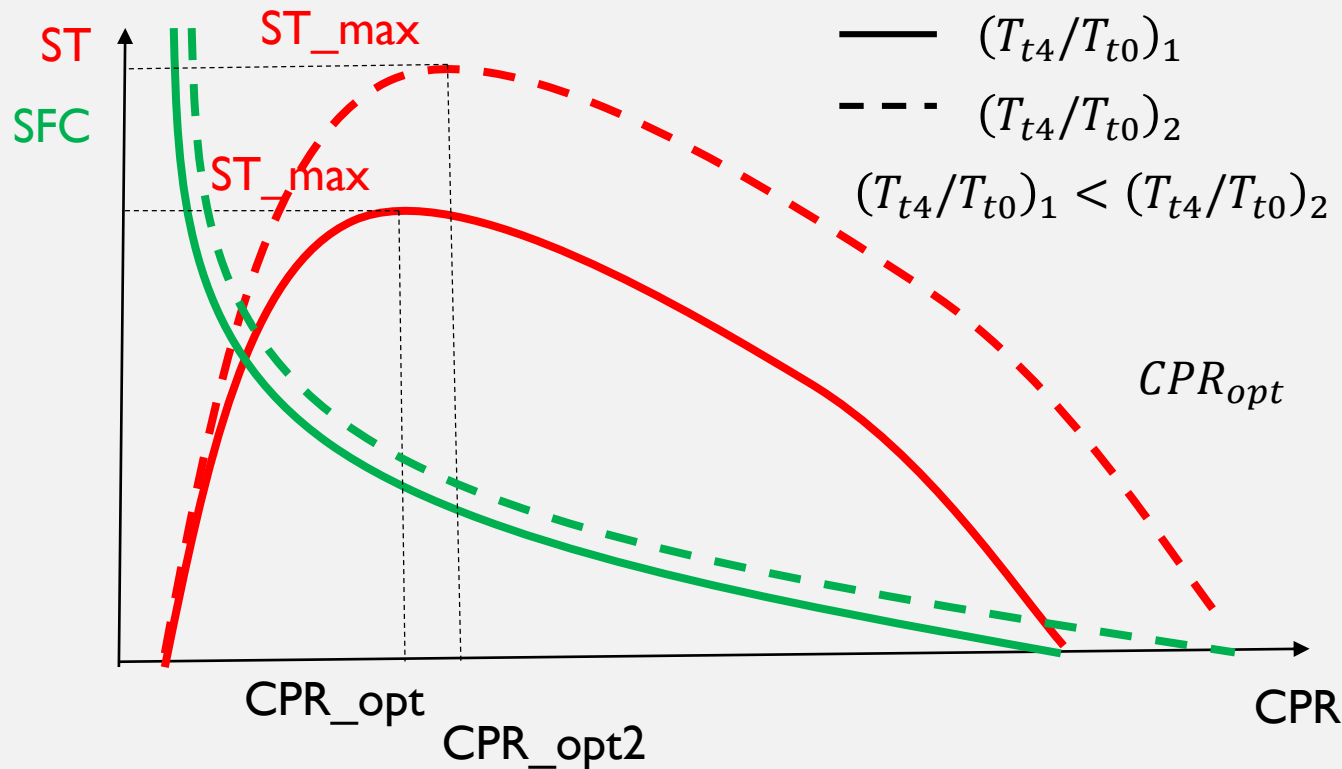

SUMMARY:

- Specific thrust (ST) is higher for higher engine temperature ratio T_{t4}/T_{t0} and achieve ST_{max} for higher CPR (higher CPR_{opt})
- Specific fuel consumption decreases with CPR growing, but for high T_{t4}/T_{t0} is higher
- Range of available CPR increases for higher T_{t4}/T_{t0}

T_{t4}/T_{t0}	CPR_{opt}	CPR_{max}
4	11,3	128
5	16,7	279,5
6	23	529

For ideal cycle:

$$\text{CPR}_{\text{opt}} = T_{t4}/T_{t0}^{\frac{k}{2(k-1)}}$$

$$\text{CPR}_{\text{max}} = \text{CPR}_{\text{opt}}^2$$

THANKS FOR YOUR ATENTION

Questions and Comments ?

1.

2.

3.